

SR-15+

TIME CODE DISTRIPALYZER

A Distributor, a Stripper and an Analyzer

Operation Manual

Software version 3.05



**BRAINSTORM
ELECTRONICS, INC.**

...Intelligent Solutions For The Recording Studio

SR-15+
TIME CODE DISTRIPLYZER

OPERATION MANUAL

BRAINSTORM ELECTRONICS, INC.

Release Date: June 1994

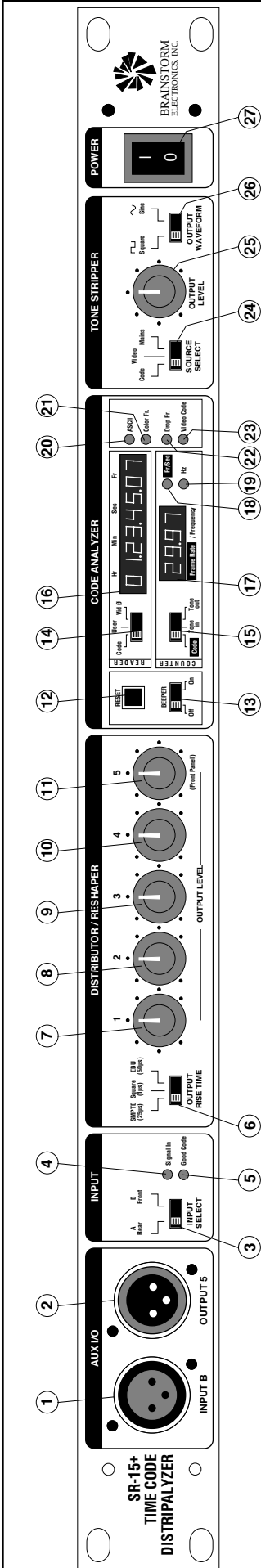

Aux I/O

- 1. Input B:** Auxiliary time code input, for easy front panel access.
- 2. Output 5:** Auxiliary time code output, for easy front panel access.

Input Section

- 3. Input Select:** This switch determines which input is active (front or rear).
- 4. Signal In LED:** Lights up when signal is present at the selected input. Any signal above -30db lights this LED.
- 5. Good Code LED:** Lights up when valid code is present at the selected input; blinks off momentarily if a "Fatal" time code error is detected.

Power

- 27. Power Switch:** Turns power on or off

Distributor

- 6. Rise Time Switch:** Changes the waveform of all 5 reshaped time code outputs: SMPTE = 25µsec, square wave = 1µsec and EBU = 50 µsec.
- 7. Output Level (7-11):** Adjusts the level of each reshaped output individually from full off to +12dbU.

Analyzer

- 12. Reset Switch:** Push button to reset SR-15+ or clear displays.
- 13. Beeper switch:** turns beeper off.
- 14. Reader Select:** Selects the mode of the 8 digit display: Time code/ User bits/ Video Ø.
- 15. Counter Select:** Selects the input and the mode of the 4 digit display : Code / Tone in / Tone out.

- 16. Reader (8 digit display):** Reads time code, user bits or video phase; identifies the error type and the faulty address.
- 17. Counter (4 digit display):** Reads the frame rate (fr/sec) of the incoming time code or the frequency (hz) of Tone in or Tone out.

- 18. Fr/Sec LED:** On when 4 digit display counts frame rate.
- 19. Hz LED:** On when 4 digit display counts frequency.

- 20. ASCII LED:** On when ASCII flags are set. On means User Bits are ASCII; off, User Bits are Hex.
- 21. Color Frame LED:** On when Color flag is set (bit 11); off when flag is not set.

- 22. Drop Frame LED:** On solid for drop frame code; blinks mostly on for missing DF flag (bit 10); blinks mostly off for false DF flag; off for non-drop.
- 23. Video Code LED:** On solid if code is synchronous and in phase with video; blinks mostly on if code is out of phase; blinks mostly off if code is drifting; off if no video is present.

Stripper

- 24. Source Select:** Selects the input of the Stripper: Code / Video / AC Mains.
- 25. Output Level:** Adjusts the Stripper's output level from full off to +12dbU
- 26. Output Waveform:** Determines the waveform of the stripped tone: Square wave / Sine wave.

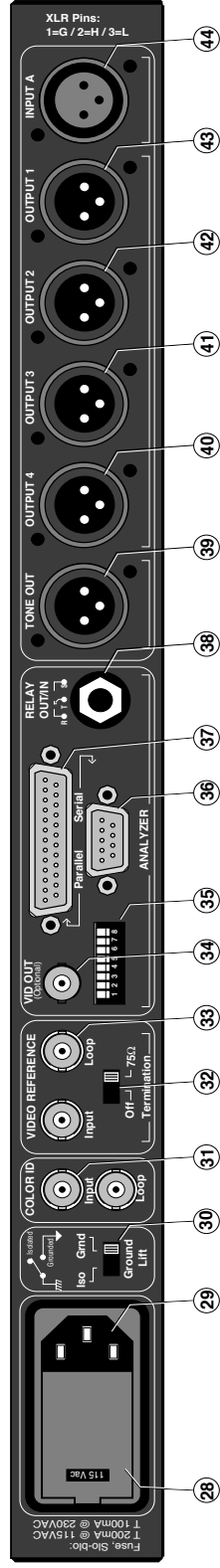

Rear Panel

- 28. Voltage Selector & Fuse drawer:** Selects 115VAC or 230VAC & holds the main fuse and a spare.
- 29. Power In:** IEC 320 power inlet.
- 30. Ground Lift Switch:** Isolates chassis ground from signal ground.

- 31. Color ID In & Loop:** Input & loop for color field ID pulse.
- 32. Termination:** 75Ω for video in & loop.
- 33. Video Reference In & Loop:** BNC jacks for video reference.
- 34. Video Out (optional):** Report output.

- 35. Dipswitches:** Future upgrades - pg 9
- 36. Serial Port:** DB-9M for RS-232 I/O.
- 37. Parallel Port:** DB-25F for Centronics printer output.
- 38. Relay out / in:** TRS 1/4" for remote "Good Code" LED or ext'l trigger input.

- 39. Tone Out:** Output of the Stripper.
- 40. Output 1-4 (40-43):** Outputs of the Distributor/ Reshaper.
- 44. Input A:** Rear panel time code input.

Table of contents

• Introduction	2
• Section 1: Setting up the SR-15+	
Connections	3
Wiring	4
Setting the SR-15+'s jumpers	6
Setting the SR-15+'s dipswitches	9
• Section 2: Using the SR-15+	
1. Time Code Analyzer	
Time Code Format and Frame Rate	10
Frame Rate vs. Format / 29.97 vs. Drop Frame	11
Proper bit width	11
Time Code / Video Phase	12
What does it mean for time code to be in phase with video?	12
How can you check video phase?	12
Color Framing	13
Reporting Time Code Errors	14
What is the difference between Reset and Clear?	15
How do you reset or clear the SR-15+?	15
Transmitting A Time Code Report	16
Using a printer with the SR-15+	16
Using a computer with the SR-15+	16
Time Code Report	17
Serial Time Code Addresses	18
2. Tone Stripper	
How to strip a pilot tone	19
How to read the frequency of the stripped tone	19
Stripper conversions	19
3. Distributor / Reshaper	
Time Code Distribution	20
Reshaping distorted time code	20
Time Code Level	20
Selecting the proper rise time	21
Reshaping Vs. Re-generating	21
• Section 3: Application notes	22
• Appendix	
A: Time Code Error Messages	25
B: More on the Frame Rate Counter	26
C: Extracting 62.50Hz tone from 25 fr/sec code	26
D: Protecting the SR-15+'s outputs from DC voltage on the load	26
E: More on the video phase display	27
F: Identifying color field with time code address	27
G: Longitudinal Bit Assignment (SMPTE & EBU)	28
• Specifications	29

Introduction

The SR-15+ time code distributor combines three functions in one unit: a distributor, a stripper and an analyzer. It should be permanently installed in your time code set up and always on line, whether you are generating time code and recording it on tape or playing it back while synchronizing several machines. This way, the SR-15+ can detect time code errors immediately, before you commit any recording to bad time code.

- The Distributor reshapes time code and distributes it through 5 individually buffered outputs;
- The Stripper extracts a synchronous field rate pilot tone from time code, video or AC mains;
- The Analyzer identifies the type, the stability and the frame rate of the incoming time code; it verifies its proper synchronization (phase) with video; and it reports time code errors (i.e. drop outs...).

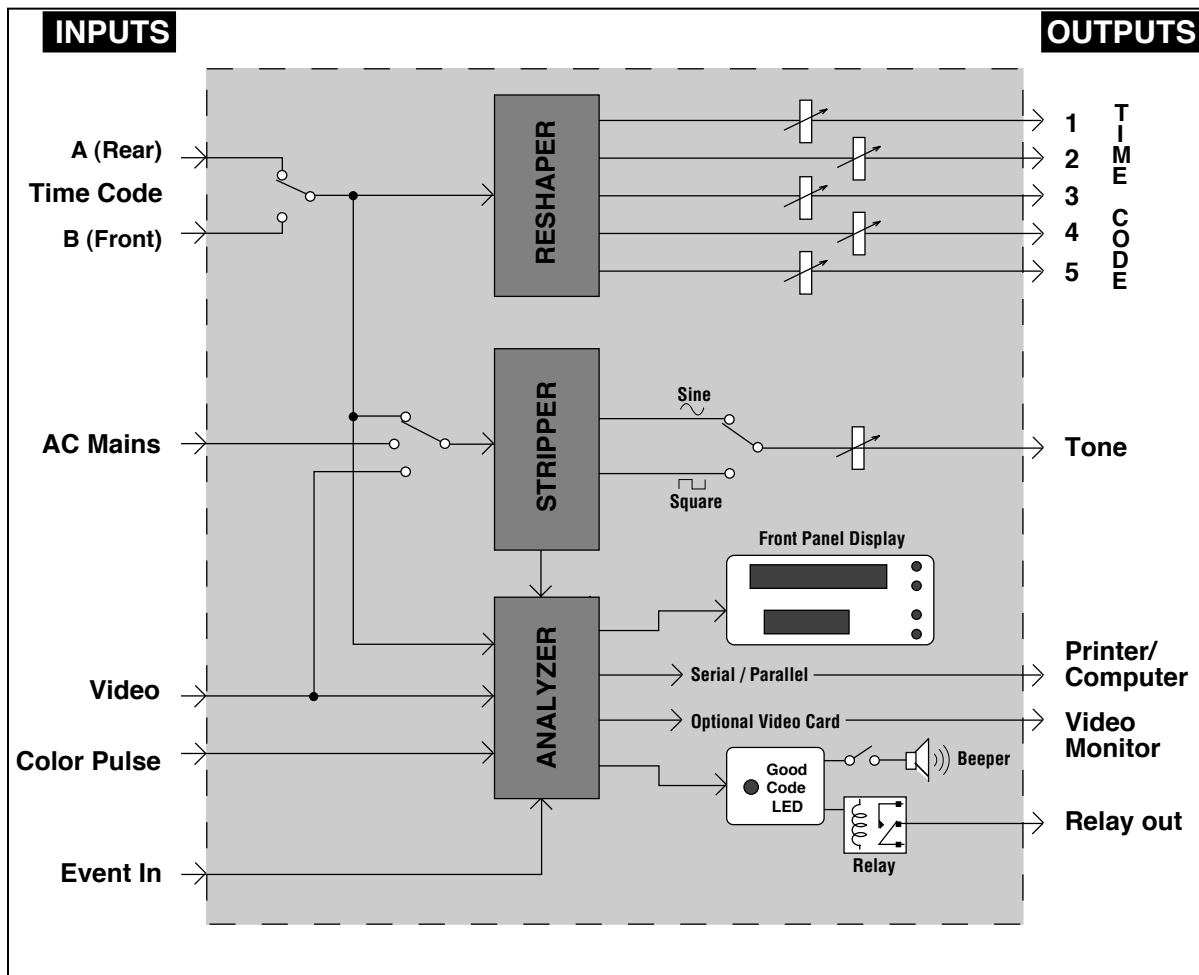

Figure 1. SR-15+ Flow Chart

Section 1: Setting up the SR-15+

1. Connections

⇒ Time Code inputs

The SR-15+ has 2 separate input jacks for time code: Input A on the rear panel and Input B (aux) on the front panel. The front panel "Input Select" switch determines which input is active. Connect your main time code source to the rear panel input jack. The front input jack is provided for an auxiliary time code source.

⇒ Time Code and Tone outputs

There are 5 reshaped time code outputs: 1 through 4 are located on the rear panel and output 5 is on the front panel. Connect these outputs to your synchronizer, reader, console automation, sequencer, workstation etc...

The Pilot Tone output is located on the rear panel. Connect this to your tone destination (i.e tape machine, resolver...).

⇒ Video Reference

Connect Video Composite Sync or Composite Video to the video reference input BNC. This signal is used by the Analyzer to monitor phase with time code and by the Stripper to extract a video referenced pilot tone. An additional BNC connector is provided for looping through as well as a switchable 75Ω termination.

⇒ Color ID

If using Color Framed Time Code, connect the Color Field ID pulse from your house Sync Generator into the rear panel Color ID input. When this pulse is present, the SR-15+ reports the time code alignment with respect to this reference. There are 2 BNC connectors on the rear panel: Color ID Input and Loop.

⇒ Video Out (optional)

Connect a video monitor to this BNC connector to view the time code report or to burn a time code window in your video.

⇒ Relay Out/In

This 1/4" jack can be set up as an input or an output (see "Setting up the SR-15+'s jumpers"). If used as an output, connect a remote "Good Code" LED to this jack; If used as an input, connect an external switch to this jack.

⇒ Parallel Port

Connect a parallel printer (Centronics) to this port to print a time code report.

⇒ Serial Port (RS-232)

Connect a serial printer to this port to print a time code report or a computer such as a Mac or a PC to capture the report on the screen and to access the SR-15+ to customize your report (future software upgrade) - see next chapter for proper wiring.

⇒ Power

CAUTION: BEFORE CONNECTING TO AC MAINS BE VERY SURE THAT THE CORRECT VOLTAGE IS SELECTED ON THE REAR PANEL AND THAT THE PROPER FUSE IS INSTALLED.

The SR-15+ can operate with 115 VAC / 230 VAC @ 50Hz / 60 Hz.

To change selected voltage: disconnect the power cord; open cover of power entry module using small blade screwdriver; remove the plastic selector by pulling it out and select desired voltage; replace selector into unit and close cover making sure the selected voltage appears in connector window.

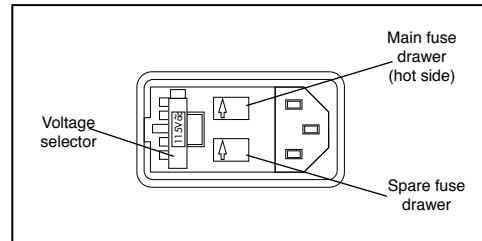

Figure 2. Rear panel power entry module (open)

IMPORTANT: if you change the voltage setting, you **MUST** also change the fuse:

In addition to the voltage selector, the power entry module also holds two fuse drawers. Since only the hot side is fused, the second drawer is not in the circuit and only serves to hold a spare fuse (see drawing above). Pull the main fuse drawer using a small blade screwdriver and check the markings on the fuse. Use the following values:

@ 115VAC: 250V T200mA (slow blow, type 218)

@ 230VAC: 250V T100mA (slow blow, type 218)

2. Wiring

⇒ XLR Connectors:

The SR-15+ uses XLR connectors for time code and tone inputs and outputs. Pins are: 1=ground, 2=high, 3=low.

Since time code is bi-phase, a reversal of low & high wires would not cause a problem. The tone however would be 180° which may cause a ½ frame error when jam syncing to tone.

The SR-15+ works with balanced and unbalanced equipment. It can balance an unbalanced signal. This can eliminate problems due to mismatched impedance and ground loops. When using unbalanced equipment with the SR-15+, wire your cables as described in the diagrams below.

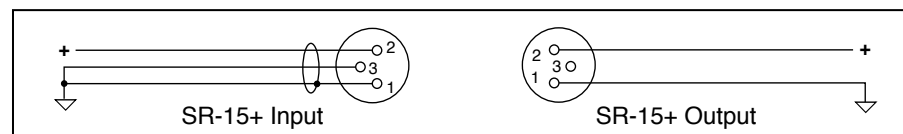

Figure 3. Proper unbalanced wiring diagrams

⇒ 1/4" Jack (Relay out/in)

This is a tip-ring-sleeve jack. It can be an output or an input depending on the position of jumpers 4 & 5 (see "Setting the SR-15+'s jumpers").

As an output, the 1/4" jack is connected to an internal relay which is activated whenever the "Good Code" LED goes on. The pins are: Tip = normally open / Ring = common / Sleeve = normally closed.

As an input, the jack is connected to the analyzer so that the SR-15+ can report each closure (from an external switch or relay connected to this jack) along with its coinciding time code address. Closure needs to be between tip and sleeve for a minimum of 1/10 second. **IMPORTANT:** You must use a stereo plug (TRS type) since a mono plug would cause a short between ring and sleeve.



Figure 4. 1/4" Jack pins

⇒ **Parallel Port (DB-25F)**

Use a regular Centronics cable (DB25P - CEN36P) to connect a parallel printer to this port.

⇒ **Serial Port (DB-9M)**

Only 3 pins are used on this connector: Pin 2 is RS-232 out (TXD); pin 3 is RS-232 in (RXD); pin 5 is ground. To connect a computer, follow the instructions below:

- **Mac:** make up a cable with an 8 pin mini Din connector on the Mac side and a 9 pin sub-D female connector on the SR-15+ side. Solder the 3 pins needed as described in the table below.



Note: For convenience, you can use a standard modem cable and replace one of the Din connectors with a DB-9F. Pins 4 (SG) and 8 (RXD+) are usually tied on the Mac side which is OK.

	SR-15+ 9 pin Sub-D	Mac 8 pin Mini Din
Signal Out	2 (TxD)	5 (RxD)
Signal In	3 (RxD)	3 (TxD)
Ground	5 (SG)	4 (SG)

- **PC:** make up a cable with 25 pin sub-D on the the PC side and a 9 pin sub-D female connector on the SR-15+ side. Solder the 3 pins needed as described in the table below.

IMPORTANT: ON THE PC SIDE (25 PIN SUB-D), PINS 6 AND 20 (DSR - DTR) MUST BE TIED TOGETHER.

	SR-15+ 9 pin Sub-D	PC 25 pin sub-D
Signal Out	2 (TxD)	3 (RxD)
Signal In	3 (RxD)	2 (TxD)
Ground	5 (SG)	7 (SG)
		6 (DSR)
		20 (DTR)

- **Serial printer:** To connect an Apple ImageWriter printer, use the above described Mac cable. For serial printer with a DB25 connector, use the PC cable. For other printers, refer to your printer's manual for pin configuration.

3. Setting the SR-15+'s Jumpers

There are 5 jumpers on the SR-15+'s mother board that control the 4 different functions listed below. To change the factory settings, remove the chassis' top panel and move the jumpers as follows:

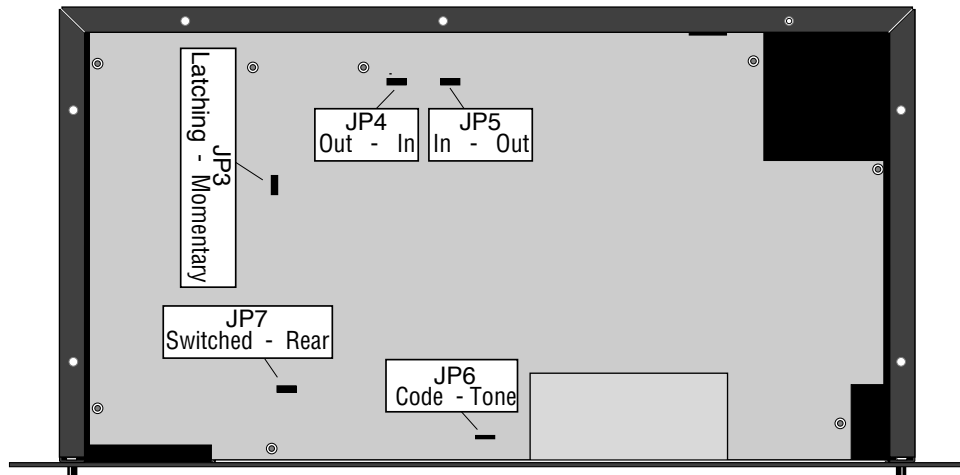

Figure 5. SR-15+ Top view

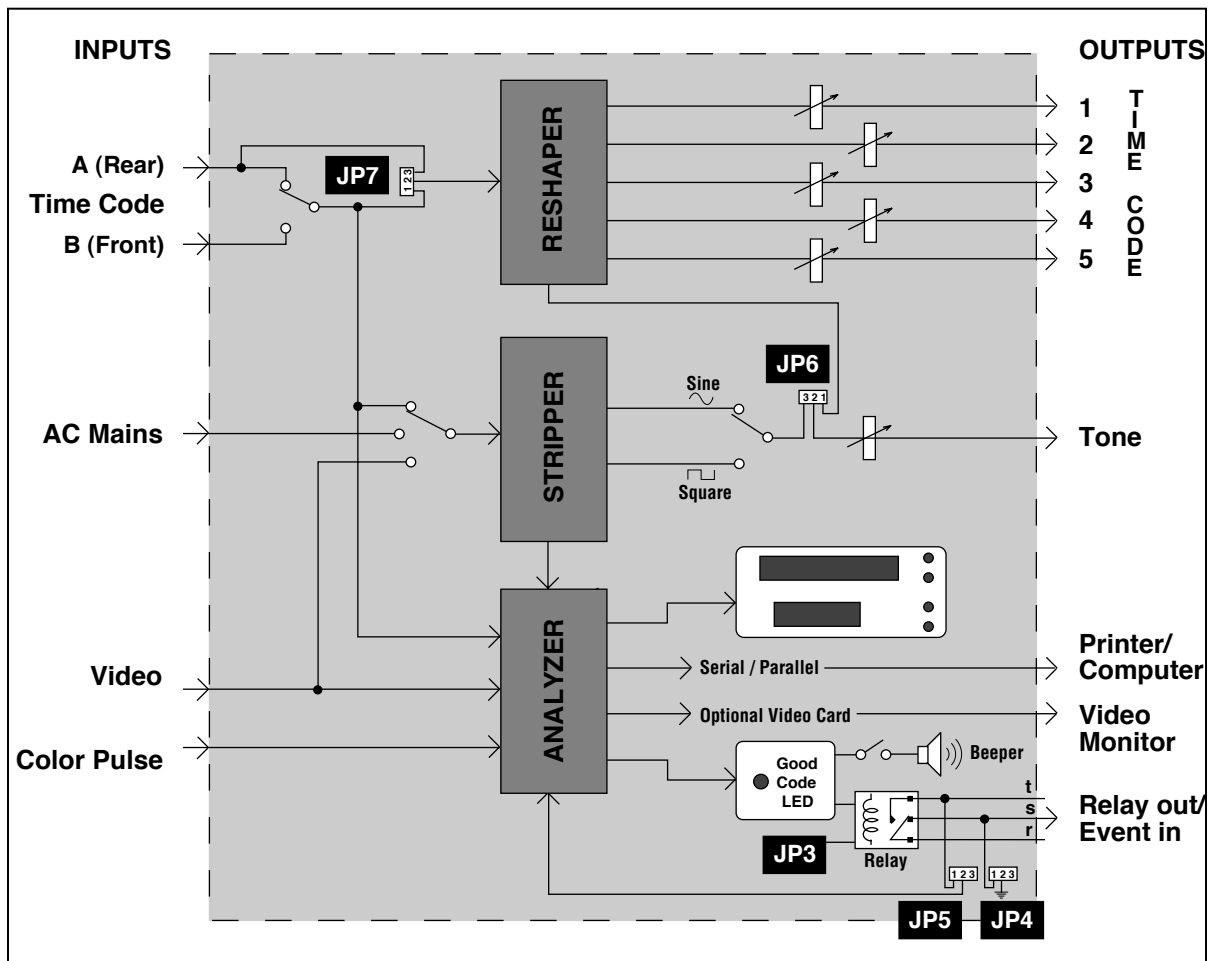

Figure 6. SR-15+ Flow Chart with Jumpers

⇒ Reshaper's input: "Switched" / "Rear" (JP7)

The front panel input selector switch determines which input is active, front or rear. This input signal is reshaped and distributed as well as analyzed by the SR-15+. However, in some situations, it may be convenient to reshape and distribute one signal and analyze another. Jumper JP7 enables you to do that by changing the reshaper's input path.

JP7 has 2 settings: "Switched" and "Rear". In the "Switched" setting, the input selector switch controls the input to the analyzer and the reshaper; in the "Rear" setting, the rear time code input is directly connected to the reshaper, bypassing the input selector switch (front panel). In this mode, the selector switch controls the analyzer's input only.

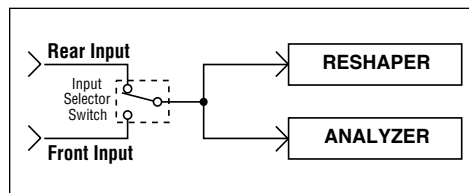

Figure 7. "Switched" position

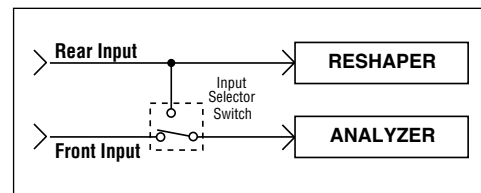

Figure 8. "Rear" Position

With JP7 set to "Rear", you can analyze an auxiliary time code patched into the front panel input jack without disrupting the reshaping of the master time code patched into the rear panel input jack.

This feature also enables you to analyze the reshaped signal if needed. Sometimes, time code is so distorted that the SR-15+ cannot analyze it properly. If this is the case, set JP7 to "Rear" and patch the front panel output into the front panel input (use a short XLR cable). With the input selector in the "Front" position, the SR-15+ analyzes the reshaped time code; with the input selector in the "Rear" position, the SR-15+ analyzes the "raw" time code.

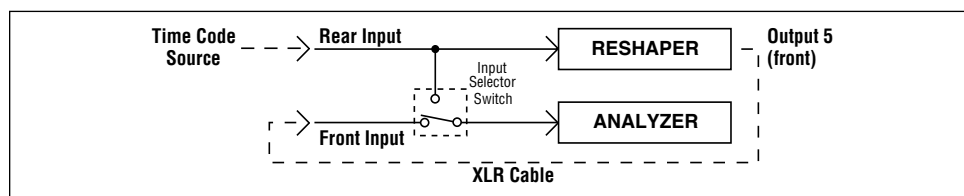

Figure 9. With JP7 in "Rear" position, you can analyze the reshaped time code.

The SR-15+ is shipped with the jumper in the "Switched" position.

NOTE: When extracting a pilot tone from code, the Stripper section always follows the front panel input selector switch, regardless of JP7's position.

⇒ Tone output: Tone / Code (JP6)

The Tone output can be converted into a sixth Time Code output if needed. To do so, move the shorting jumper on JP6 to the left position ("Code"). In this mode, the Stripper section of the SR-15+ no longer has an output. The Tone pot on the front panel (Stripper section) controls the level of the 6th code output ("Tone Out" XLR).

The SR-15+ is shipped with JP6 in the "Tone" position.

⇒ **1/4" Jack: Relay out / Event In (JP4 & JP5)**

The rear panel 1/4" jack can serve as an input or as an output:

- Output setting: the 1/4" jack is connected to an internal relay which is activated whenever the "Good Code" LED goes on;
- Input setting: an external switch can be connected to the 1/4" jack so that the SR-15+ can report each closure along with its coinciding time code address.

For "Relay out": move shorting jumper on JP4 to the left and on JP5 to the right.

For "Event in": move shorting jumper on JP4 to the right and on JP5 to the left.

The SR-15+ is shipped with the 1/4" jack set for "Relay out".

⇒ **Relay: Latching / momentary (JP3)**

The internal relay has 2 different modes of operation:

- Latching: the relay is open when the "Good Code" led is off and closes when the led is on.
- Momentary: the relay closes for approximately 100ms when the "Good Code" led goes from on to off;

The SR-15+ is shipped with the relay in the "Latching" mode. To set it to the "Momentary" mode, move the shorting jumper on JP3 to the 2 pins closest to the front panel.

4. Setting the SR-15+'s Dipswitches (rear panel)

There are 8 switches on the SR-15+'s rear panel. Most of these switches are reserved for future upgrades.

Only two switches are presently used.

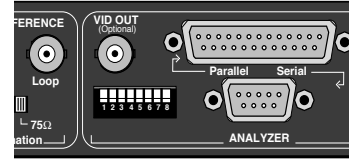

⇒ **Switch #1:**

Not used - Future upgrade

⇒ **Switch #2:**

Not used - Future upgrade

⇒ **Switch #3:**

Not used - Future upgrade

⇒ **Switch #4:**

Not used - Future upgrade

⇒ **Switch #5:**

Not used - Future upgrade

⇒ **Switch #6:**

Not used - Future upgrade

⇒ **Switch #7:**

This switch is used for selecting 4 or 8 fields PAL color sequence. The default setting (off or up position) is for 4 fields; the other (on or down position) is for 8 fields. See page 13 for more on color framing.

⇒ **Switch #8:**

With this switch off (up position), the time code report is transmitted through both the serial and parallel ports (see page 17).

Turning switch #8 on (down position) disconnects the parallel port and changes the serial port output so that, instead of transmitting the regular time code report, the serial port transmits time code addresses as ASCII characters (see page 18).

Section 2: Using the SR-15+

1. Time Code Analyzer

The Analyzer section has 3 main functions:

- to identify the format and frame rate of the incoming time code;
- to verify the proper synchronization (phase) with video;
- to detect and report time code errors.

A. TIME CODE FORMAT & FRAME RATE

When playing time code into the SR-15+, the analyzer first identifies its format:

- ⇒ **Reader Display:** As soon as valid time code is recognized, its format (or frame count) is indicated in the **8 digit display** for about 2 seconds. The display then automatically switches to its selected mode (time code, user bits or video Ø).



THE 3 STANDARD TIME CODE FORMATS ARE: 24, 25 OR 30 FR/SEC.

- ⇒ The **4 LED's** on the right of the display further identify the time code:

- The **ASCII LED** indicates the user bits' format.

If the LED is off, UB format is Hex; if the LED is on, UB format is ASCII. ASCII is often used to identify a scene, reel, date or camera number .

- The **Color Frame LED** indicates whether code is "color framed" or not.

This LED comes on if the color flag is set (bit 11); it is off if the flag is not set. For more on "Color Framing", see page 13.

- The **Drop Frame LED** indicates the drop-frame status.

This LED comes on as soon as the microprocessor detects a drop frame flag (bit 10 set). But the SR-15+ also monitors the code to make sure the proper frames are actually being dropped. If they are not, the LED blinks mostly off (false flag). If frames are properly dropped but the DF flag was not detected, the LED blinks mostly on (missing flag).

Note: Since frames are dropped at the end of the minutes, this LED will not start blinking until the microprocessor sees a minute boundary of good code.

- The **Video Code LED** : Indicates whether code is in sync with video or not.

This LED comes on only if a video reference is present. For the different modes of this LED, see page 12.

- ⇒ The **4 digit display** indicates the frame rate (or frequency). The SR-15+ strips the bit clock from the incoming time code and displays it as frames per seconds. It displays any rate from approximately 21 to 39 fr/sec.



The frame rate counter is updated 4 times per second. Since its resolution is $\pm .01$ fr/sec, it can show potential problems such as jitter (see Appendix B "More on the frame rate counter" on page 26).

Format vs. Frame Rate

The SR-15+'s 4 digit display indicates frame rate, NOT format. There is a distinction. The format does not deal with frequency. It is a way of counting:

at 30 fr/sec, the frame sequence is: 28, 29, 00, 01, etc...

at 25 fr/sec, the frame sequence is: 23, 24, 00, 01, etc...

at 24 fr/sec, the frame sequence is: 22, 23, 00, 01, etc...

The frame rate on the other hand does not deal with count but frequency. If the tape speed varies, the frame rate varies. For example, if a tape machine was running 5% too fast, a format of 24 fr/sec would have a frame rate of 25.20 fr/sec. Yet the format would remain 24 fr/sec.

29.97 vs. Drop Frame

Many people confuse 29.97 with drop-frame but they are not the same thing: 29.97 indicates a rate (frequency) and drop-frame indicates a format (count).

"29.97" time code is 30 fr/sec code with a rate of 29.97. When generating 29.97 time code, the generator locks to a field rate of 59.94 Hz (NTSC color rate) and pulls down the frame rate by .1% to 29.97. But the format or frame count remains 30 fr/sec.

Drop Frame on the other hand is another way of counting frames. It is a variation of 30 fr/sec format, invented to compensate for the color rate of 29.97. Drop frame code leaves certain frame numbers out so that one hour of code time equals one hour of stopwatch time when code is running at 29.97.

Drop and non-drop code can both be generated at a rate of 30 or 29.97 fr/sec. For that reason, the frame rate and the drop frame status are displayed separately on the SR-15+'s front panel.

Proper bit width

In LTC, each word is divided into 80 equal segments called bits, numbered 0 to 79 (for bit assignment, see appendix G on page 28). Each bit can either be a "one" or a "zero": a "one" has a level shift halfway through its width; a "zero" does not. The time between each level shift can easily be calculated:

At 30 fr/sec it is 417 μ s for a "zero" and 208 μ s for a "one",

At 25 fr/sec it is 500 μ s for a "zero" and 250 μ s for a "one",

At 24 fr/sec it is 521 μ s for a "zero" and 260 μ s for a "one".

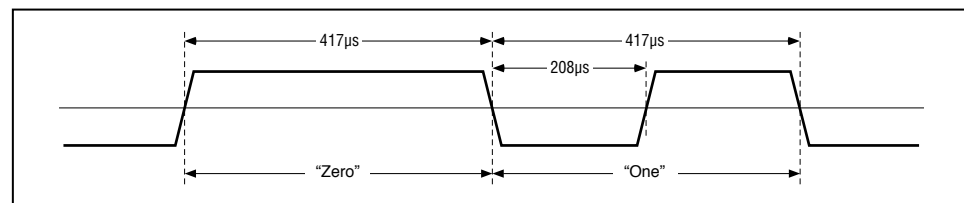

Figure 10. Bit width at 30 fr/sec.

The SR-15+ has a $\pm 25\%$ window which means that at 30 fr/sec, the level of a "zero" could remain constant for 313 to 521 μ s and of a "one" for 156 to 260 μ s.

However, some VCR's distort the bit width beyond that window (the "one's" become too narrow). If the SR-15+ does not recognize valid time code with a signal present at its input for over 1 second, it switches automatically to an alternate setting to accommodate these distortions. If time code is then recognized, a "alternate bit width window" message is reported in the time code report.

The SR-15+ remains on this alternate setting until reset (automatically or manually).

B. TIME CODE / VIDEO PHASE

What does it mean for time code to be in phase with video?

When time code is recorded on video tape, it must be synchronous with the video signal, meaning that the beginning of each time code word must coincide with the beginning of the video frame it describes. This is essential for video editing.

There is one time code word for each frame. Each word is made up of 80 bits, numbered from 00 to 79 (see diagram below). Time code is phased properly with video when the end of bit 79 of time code lines up with field 1 line 5 of video (± 1 line).

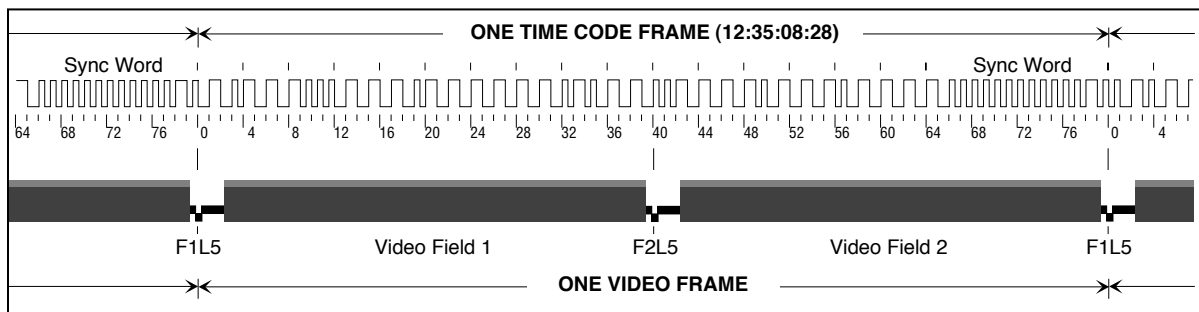

Figure 11. Proper alignment of time code and video

How can you check video phase with the SR-15+?

- ⇒ The **Video Code LED** indicates 4 different conditions:
 - on means: time code is properly phased with video;
 - blinking mostly on means: time code is resolved with video but out of phase;
 - blinking mostly off means: time code is non-synchronous (drifting);
 - off means: no video is present.

The SR-15+ considers time code “properly phased” if the time code bit lined up with video F1L5 is between numbers 75 and 04.

The SR-15+ considers it “non-synchronous” if time code moves by more than 2 bits with respect to video F1L5.

If the time code generator was mistakenly set to internal crystal instead of external video, there would be a very slow drift between time code and video. The SR-15+ reports this drift as soon as time code moves by more than 2 bits with respect to F1L5, even if it is within the “properly phased” window.

- ⇒ On the **reader display** you can monitor the sync between time code and video:
 - With its selector switch in the “video 0” position, the reader shows which bit of the time code word lines up with video Field 1 Line 5 (“V” drive).

-b. 16.79

With synchronous code, the display should read: “bit 79”. In the real world however, things are different and phase will often be slightly off. For example, if the display reads “bit 68” or “bit 07”, the address track was possibly misaligned on the VCR and your synchronizer may show some slight sub-frame offset (i.e. 03, 12, etc) when locked to code like this. So long as you are within a few bits of 79 and the bit number stays the same, you should have no problems.

-b. 16.75.76

Note: If “V” drive is at the edge of a time code bit, 2 bit numbers (those on either sides of that edge) will flicker in the display:

WARNING: IF THE BIT NUMBER DRIFTS, TIME CODE IS ASYNCHRONOUS AND MAY BE USELESS FOR YOUR APPLICATION.

Color Framing

The signals carrying color information within the video signal (chrominance) follow their own cyclic evolution. The relationship between the color sub-carrier and the video sync is too complex to describe here, but it is important to know that this relationship must be maintained during editing to avoid picture disturbance.

For NTSC, SECAM and simple PAL editing, the color sequence is spread over 4 fields (2 frames); for more complex PAL editing, it is spread over 8 fields (4 frames).

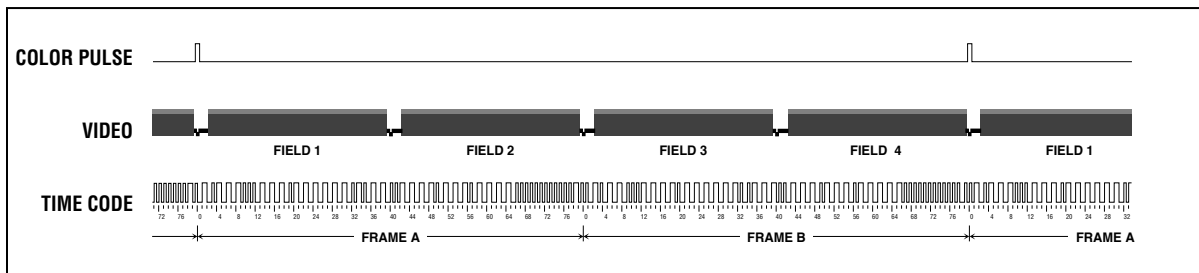

Figure 12. NTSC 4 Field Color Sequence

A “color frame” standard was developed for SMPTE and EBU time codes so that the position of each frame in the color sequence could be identified by using the time code address rather than the video signal (see Appendix F on page 27). When generating such time code, the field ID pulse from the house sync generator is fed into the time code generator. The time code generator locks to that pulse (so that the first time code frame of the color sequence begins at the ID pulse) and sets a flag (bit 11) to identify color framed time code.

How can you check proper color framing with the SR-15+?

To verify the proper color framing of your time code, connect the field ID pulse from your house sync generator into the SR-15+’s Color ID input (rear panel BNC).

NOTE: With EBU, you must let the SR-15+ know if the color sequence is 4 or 8 fields long. Turn dipswitch #7 on for 8 fields and off for 4 fields (see page 9)

- ⇒ **Reader Display:** When the selector switch is set to “video 0”, the first digit of the display shows which field, derived from the time code address, is aligned with the ID pulse. If no pulse is present, the SR-15+ puts a dash across the first digit.

IMPORTANT NOTE: The SR-15+ does not extract the field numbers from the video signal but from the time code address.

- ⇒ **Color Frame LED:** If the color flag is set (i.e. time code bit 11 is a binary one), this led comes on; if not, it stays off.

C. REPORTING TIME CODE ERRORS

One of the functions of the analyzer section is to detect and report time code errors. Errors considered serious enough to cause a synchronizer problem (such as a repeated frame) are labeled "fatal" by the SR-15+. Others are "non-fatal". For a complete list, see appendix A on page 25.

Reporting errors on the SR-15+ front panel

All "fatal" errors are reported on the front panel; "fatal" and "non fatal" errors are both reported on the printed report.

⇒ The 8 digit display:

Every time the SR-15+ detects a "fatal" error, the reader is momentarily interrupted and displays a description of the error (i.e. "Drop-out" etc...) for about 2 seconds. Then it returns to its selected mode of operations (time code, user bits or video ø).

After the SR-15+ has detected a "fatal" error, the first digit of the reader display blinks continuously (until cleared or reset). This way, if you leave the room, you will know if an error occurred while you were away.

After tape has been stopped (code must be interrupted for at least 5 seconds), the 8 digit display shows a description of the first "fatal" error detected for about 2 seconds. After these 2 seconds, it indicates where the error occurred and then alternates between the faulty address and its description.

If no error occurred, the display alternates between a "Code Stopped" message and the last valid time code address.

View the first five errors: The SR-15+ keeps the first 5 errors detected in memory. After time code has been stopped, tap the reset button to toggle through them. Each tap advances the display to the next error until the fifth one. Then it returns to the first. For each error, the display alternates between the faulty address and its description.

Front panel error messages:

Here is a list of error messages as they are reported on the 8 digit display:

DROP OUT: Drop out - Code interruption for less than 1 second.

CODESTOP: Code Stopped - Code interruption for 1 second or more.

DISCONT: Discontinuous Address or repeated frame

INVALID: Invalid Address - Any non valid number such as 39 frames.

VID-LOST: Video Loss - Any interruption in the video signal.

FORM CHG: Format Change

DROP X: Wrong number of frames dropped (X indicates the number of frames)

DROP CHG: Change in the Drop Frame Status

COLR CHG: Change in the Color Frame status

In addition to the 8 digit display, the SR-15+ also alerts you of errors as follows:

- ⇒ The **“Good Code” LED** (input section) blinks off momentarily whenever a “fatal” error is detected.
- ⇒ The **Beeper** sounds whenever the “GOOD CODE” LED changes from on to off. If necessary, the beeper can be turned off via the front panel on/off switch.
- ⇒ The **Event Relay** is activated whenever the front panel’s “GOOD CODE” LED goes on. This relay has 2 different modes of operation (see “Setting the SR-15+’s jumpers” on page 8):
 - **Latching:** the relay is open when the “Good Code” led is off and closed when led is on. This can be used to connect a remote “good code” LED.
 - **Momentary:** the relay closes approximately 100ms when the “Good Code” led goes from on to off. This can be used to stop the tape machine as soon as a fatal error is detected, for example.

The SR-15+ keeps track of errors and statuses on the front panel and it may be useful at times to reset the SR-15+ or clear some of its displays.

What is the difference between Reset and Clear?

- **Reset:** When you reset the SR-15+, it is as if you were playing new time code. After a reset, the SR-15+ begins the normal sequence again:
 - the SR-15+ identifies the time code format and displays it for about 2 seconds in the 8 digit display (see page 10);
 - the front panel LED’s are all reset;
 - the “first 5 errors” register is erased;
 - a new time code report is initiated (through the serial & parallel ports).
- **Clear:** A “Clear” command clears some of the SR-15+’s displays:
 - If an error has been detected and the 1st digit of the reader is blinking, a clear command stops the blinking and clears the “first 5 errors” register (i.e. the next error detected will now be considered to be the first error).
 - If the video code LED was blinking, a clear command stops the blink and resets the LED.

How do you reset or clear the SR-15+?

- **Manual Reset:** To manually reset the SR-15+, press and hold the reset button for at least 1 second. The 8 digit display will say: “- reset -”
- **Auto Reset:** When code is interrupted for at least 5 seconds an end of report is initiated. When code is reintroduced, the SR-15+ is automatically reset.
- **Manual Clear:** Tapping the reset button while code is running clears the displays as described above.
- **Auto Clear (partial):** When code is interrupted for at least 1 second, the video code LED is automatically cleared when code is reintroduced.

D. TRANSMITTING A TIME CODE REPORT

A complete report including "fatal" and "non-fatal" errors as well as format information can be sent to an external printer or computer through the rear panel parallel and serial ports.

Using a Printer with the SR-15+

To send a time code report to a printer, connect it to the appropriate port, turn it on and set it so that it is ready to print ("on line").

When you play time code into the SR-15+, a report is immediately initiated (see time code report on page 17). The header is first printed, as well as the format, the video reference information and the start time.

The SR-15+ then prints the title "address errors" and waits for errors to happen. As soon as they occur, the faulty address and a description of the error is printed.

An end of report is printed automatically when time code is interrupted for at least 5 seconds. This includes a summary and the end time. In the summary, the SR-15+ reports general comments such as Time Code properly synced with Video (or not) and non standard formats such as Color Framed Code not synced with Video or 25 Drop code etc...

Both serial and parallel printers can be used with the SR-15+. However, you should use the kind of printer that prints one line at a time such as dot matrix printers and not full page printers such as laser printers.

If you want to use a laser printer, you should first send the report to a computer, as described below, then send the report from the computer to the laser printer. This would also allow you to customize the report, if needed, by adding information such as the date, the name of the studio, the name the client, etc...

Using a Computer with the SR-15+

1. Connect the SR-15+ to a serial port of your computer (see page 5 for wiring information). On the Mac, you can use the Modem or the Printer port.
2. Launch any communication program (i.e. modem program), set your computer for direct connection (not through phone connection), select the proper serial port and set the speed and format as follows:

Transmission speed:	9600 baud
Bits per character:	8
Stop bits:	1
Parity:	None

3. The procedure to send a report to a computer is identical to the one for a printer: as soon as you play time code into the SR-15+, a report appears on the screen. If any errors are detected, they will be reported as they occur. An end of report will automatically be generated as soon as input is interrupted for at least 5 seconds.

Time Code Report

The time code report includes 7 sections:

1. Header

Line 1: BRAINSTORM SR15+ VER #.##

Line 2: TIME CODE DISTRIPLYZER

Line 3: TIME CODE REPORT

2. Format:

Frame count & drop status :

24, 25, 30 Drop Frame or 30Non Drop

Color bit status: reported only if active :

Color Bit active

Parity bit status: reported only if active:

Parity bit active

User Bits format:

User Bits: HEX or ASCII

User Bits message:

first UB message detected is printed

NOTE: If SR-15+ had to switch to the alternate setting to read time code (see "Proper bit width" on page 11), the following message is printed just above the "Format" heading:

Alternate bit width window

```

BRAINSTORM SR-15+ Ver 3.05
Time Code Distripalyzer
TIME CODE REPORT
-----
Alternate Bit Width Window

*** FORMAT ***
30 Drop Frame
Color Bit active
User bits: HEX
01234567

*** VIDEO REFERENCE ***
Present
"V" drive at bit 79
*** START TIME ***
01.00.00.00
-----
*** ADDRESS ERRORS ***

01.12.36.05 Drop out
01.18.41.23 Bad bits: 28
01.18.41.27 Frame repeated
01.23.45.07 Code stopped
-----
*** SUMMARY ***
VIDEO SYNC: Code Properly Synced
COLOR: Field 1 locked with color ID pulse

*** END TIME ***
01.23.45.07
END OF REPORT

```

3. Video Reference

If video is present, the SR-15+ reports which bit of time code is lined up with "V" drive (video field 1 line 5) 3 seconds after time code is detected (to allow for ramp up time);

if video is not present, the SR-15+ reports: Video not present.

4. Start Time

First valid Time Code address.

5. Address Errors

The SR-15+ prints the title "ADDRESS ERRORS", then waits for errors to occur. As soon as an error is detected, the faulty address and the error description are transmitted.

6. Summary

When input is interrupted for 5 seconds, an end of report is printed which includes the following::

Video Sync (if video reference was present):

code properly synced / resolved but out of phase / non synchronous

Color Framing (if color flag was set and color pulse was present):

Field X locked with color ID

Non-standard formats (if applicable):

24DF / 25 DF / non synchronous color code / Undefined bit set

7. End Time

The last valid address is printed at the very end of the report.

Serial Time Code Addresses

In some situations, when analyzing time code, it is useful to view each address sequentially to make sure that no frame is missing or repeated etc...

Pressing switch #8 on (down position) changes the serial port output so that, instead of transmitting the regular time code report, the SR-15+ uses the serial port to transmit time code addresses to a computer screen. These numbers are transmitted as ASCII characters.

The computer screen displays each time code address, as read by the SR-15+, one per line. Whenever time code is interrupted for 1 second or more (i.e. code stopped), a line is skipped. Whenever a fatal error is detected, the corresponding time code address is moved one space to the right so that it can easily be found when scrolling through these addresses.

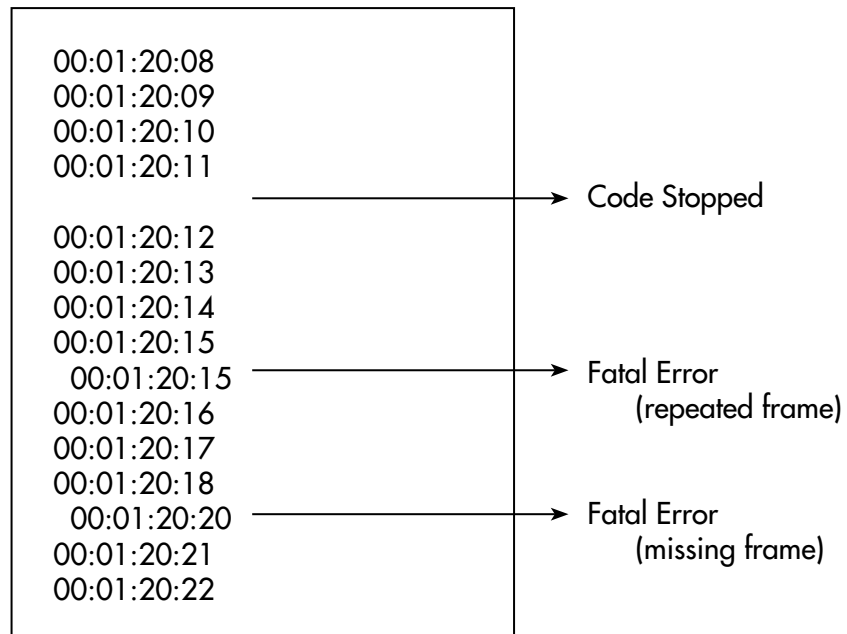

This serial output should be sent to a computer with scrolling capabilities since at 30 frames per second, just a few seconds will fill several screens and it would be necessary to scroll up and down to find the trouble spot.

2. Tone Stripper

The SR-15+ can extract a pilot tone (at field rate) from time code, video or AC mains. This tone is synchronous with its source. Its zero crossing is synchronous with and its waveform rises at:

- the end of the sync word (bit 79) of the code source,
- F1L5 of external video source or
- the 0 crossing of AC mains source

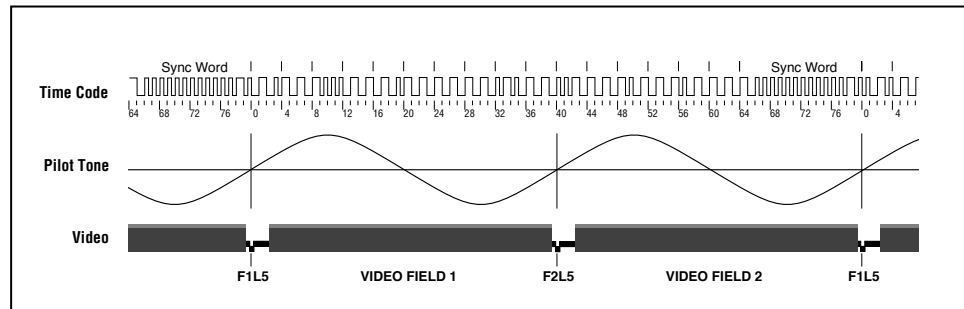

Figure 13. Alignment of pilot tone in reference to code and video

To strip a pilot tone:

1. select the source (time code, video or AC mains),
2. select the waveform (sine or square),
3. set the output level.

To read the frequency of the stripped tone:

The 4 digit display is a hi-resolution frequency counter. To read the frequency of the stripped tone, set the 4 digit display selector to "Tone Out".



To read the frequency of a recorded tone:

You can also read the frequency of an external tone: patch it into the selected XLR input and set the 4 digit display to "Tone In". The SR-15+ reads any frequency from 5 to 99.99 Hz. If a tone is patched into the SR-15+, the 8 digit display reads: " - tone - ".

The Stripper does the following conversions:

Code	29.97 fr/sec	59.94 Hz
	30 fr/sec	60 Hz
	25 fr/sec	50 Hz
	24 fr/sec	60 Hz
Video	NTSC Color	59.94 Hz
	PAL	50 Hz

3. Distributor / Reshaper

TIME CODE DISTRIBUTION

In today's studio, more and more pieces of equipment rely on time code for precise timing: console automations, sequencers, DAW's, readers, synchronizers, editors etc...

Simply multhing a single output of a tape machine or of a generator is not recommended because it can cause serious problems:

- Multhing a single output ties the destinations' inputs together. If one piece of gear is miswired and creates a short, all destinations will be affected. This could easily happen since, until recently, there was no universal standard regarding XLR pins 2 and 3.
- Heavy loading from high capacitance cables and/or low impedance loads can cause source distortions and instability.

The SR-15+ eliminates these problems by providing 5 individually buffered and balanced outputs.

In addition to distributing time code, the SR-15+ also reshapes it.

RESHAPING DISTORTED TIME CODE

When time code comes off a tape machine (especially VCR's), it usually has improper rise/fall times, leading edge peaking and different amplitude levels on "one's" and "zero's" (see diagrams below). This is due to the fact that analog tape machines were not designed to record a signal that is basically digital.

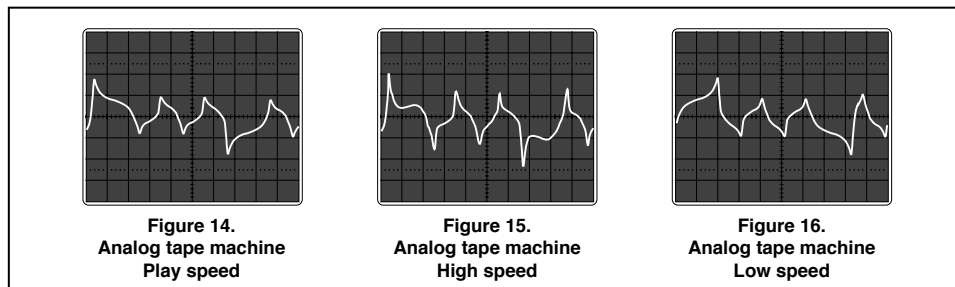

This can make the time code difficult or sometimes impossible to read. The SR-15+ eliminates these amplitude distortions by reshaping the code to its original SMPTE or EBU specifications.

TIME CODE LEVEL

Some readers operate best when time code is at a specific level. The problem is that this is not necessarily the level at which it was recorded. Also, if this level fluctuates and/or drops below the reader's threshold, time code can become unreadable.

With the SR-15+, you can adjust each output level individually so that optimum levels can be sent to each reader. These levels will remain constant regardless of input level fluctuations.

Since the SR-15+'s input threshold is lower than many readers (better than -30dB), it can reshape and recover time code that many synchronizers can't read.

SELECTING THE PROPER RISE TIME

Per SMPTE and EBU specifications, the rise time limiting is used to minimize crosstalk from time code into audio. A longer rise time removes more high frequency components from its waveform. However some equipment may not be able to read time code if its rise time is too long.

The SR-15+ has three preset rise times for its output waveform: 25 μ sec (SMPTE), 1 μ sec (square wave) and 50 μ sec (EBU).

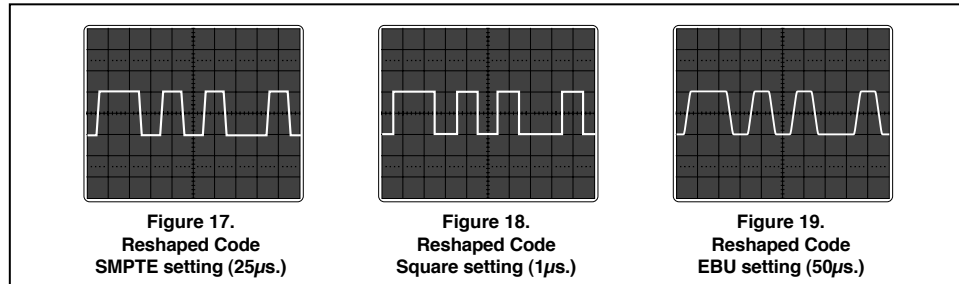

As a general rule, if time code is patched directly into a reader, use the square wave position; but, whenever possible cross-talk problems exist (i.e. in an audio patchbay...) or when recording the reshaped signal, use the SMPTE or EBU setting (as needed).

RE-SHAPING VS. RE-GENERATING

When doing transfers, some engineers like to pre-stripe time code onto tape, others like to reshape time code and others prefer to regenerate it.

In most situations, pre-stripping the tape while the tape machine is running at its own internal fixed speed is the best solution. Assuming that the generator is working properly, this would insure a clean and error free time code track. The audio tracks could then be transferred while the master and slave machines are locked. If you choose instead to reshape or regenerate, it is important to recognize that they are different and what their drawbacks are.

A reshaper does not generate new time code. It cleans up an existing time code by eliminating amplitude distortions. This means that the reshaped time code is always identical to the source time code. However, if the source is temporarily interrupted (i.e. drop out), a reshaper does not fill the gap. Also, timing distortions (i.e. jitter, wow or flutter) are transferred through a reshaper.

Regenerating time code on the other hand requires a generator. When regenerating, the generator reads an external time code source and regenerates a new code which has the same frame numbers. Regenerating can be used to repair drop outs, eliminate timing distortions or insert user bits.

However, when regenerating, it is extremely important to set the generator properly. Some generators can be set to accept two reference sources, one supplying the frame numbers and another supplying the clock (frame rate). If those two sources are not synchronous, errors will be generated. For example, if the generator is set to regenerate time code locked to video (29.97 fr/sec) and the source code has a rate of 30 fr/sec, the generator will drop some frames to make up for the slower frame rate.

When transferring code by reshaping or regenerating it, you should analyze the transferred code with the SR-15+ to insure its integrity.

Section 3: Application notes

As a general rule, it is always better to know about time code problems early rather than late in a project. More options are available early on to fix the problem and if it cannot be fixed and you have to start over, at least less time has been wasted.

For this reason, the SR-15+ has been designed to be an integral part of your time code set up and, as much as possible, should always be used, not just when a problem occurs.

Here are some specific suggestions regarding the use of the SR-15+:

1. When striping a tape, run time code through the SR-15+

Don't take your time code generator for granted. Maybe you didn't set it properly, maybe one of the LED's is blown, maybe the instructions are not clear, maybe it is broken. There are plenty of good reasons why your generator could generate something different than what you wanted.

Patch the output of your time code generator into the SR-15+ and one of the SR-15+'s reshaped outputs into your tape machine. Through the SR-15+ you can adjust the level to tape and monitor your generator. At this stage, if there are any errors, you only have to re-stripe correctly to fix the problem. It could be a lot worse if discovered later...

You can even print a report during recording by analyzing the recorded time code off the playback head. The report will show any problem with the generator or with the recording.

2. Print a time code report from pre-striped tapes

When working with a pre-striped tape, you should run this time code through the SR-15+ and print a complete report as soon as possible, preferably before you even start the session. See if the format is correct, check the video phase and make sure there are no drop outs or any other type of errors.

If a client brings a tape with faulty time code to your studio, he will usually blame your equipment for the sync problems and it can be very frustrating. The time code report ends any argument before it is even started.

If you are a composer and you receive a work copy from a transfer house, you can save a lot of aggravations by finding out about non-synchronous time code before you record any music.

If you do not have time to run the tape through the analyzer before the start of the session, make sure that the time code is running through the SR-15+ during the session.

3. Run your time code through the reshaper / distributor

The SR-15+ includes a high quality reshaper/distributor. Simply by sending your master time code through the SR-15+, a lot of problems will be eliminated without doing anything: amplitude distortions, low levels, level fluctuations, ground loops, mults etc...

4. Other applications for the reshaper

Dubbing time code

Never re-record time code by direct transfer. The accumulated distortions can make it very unreliable. Instead, if no generator is available, patch your time code into the SR-15+ and record the reshaped output. Set the rise time switch to SMPTE or EBU (as needed) and adjust the output level for optimum recording.

Variable speed reshaping

The SR-15+ can reshape time code over a very wide range of speeds in forward and reverse for use with variable speed readers. For high speed reshaping set the rise time to 1 μ sec (square wave) so high frequencies won't get filtered out.

Time code in remote trucks

Long cables can induce ringing or rounding off of the signal and render time code unreadable. The SR-15+ can drive several hundred feet of cable and remain stable. This makes it ideal for sending time code to or from a remote truck.

5. Pilot tone applications

Pilot tone is often used in **film work** with resolvers.

Some **digital audio workstations** need a field rate square wave locked to video.

Pilot tone is also used as a **time code safety**: when recording time code on track 24, also record the sync tone on track 23. If anything happens to track 24 (i.e. accidental punch in...), you can use track 23 to feed a resolver to maintain speed or to resolve a generator while jamsyncing from track 24.

If you need to **convert 24 f/s code to 30 f/s**, strip 60 Hz from your 24 f/s code, patch the stripped tone into your generator's Field Rate Tone input and generate 30 f/s resolved to external tone reference.

6. Align your VCR's address track

You can align the address track on your VCR by connecting the address track time code and the video signal into your SR-15+.

Select "video \emptyset " on the reader selector switch and move the address track head until you read "bit 00"; then move it back a little and stop as soon as you read "bit 79". This way, the trailing edge of bit 79 will be aligned with F1L5 (see figure 21 on page 27).

7. Verify the sequence of your time code addresses.

If you have problems with time code and need to find out exactly what frame sequence you have, press dipswitch #8 on (down position) and connect the serial port to a computer (see page 18).

The computer will display each time code address sequentially, as read by the SR-15+. This way, you will see exactly if any frame is repeated or missing. Make sure your computer has scrolling capabilities since at 30 frames per second, just a few seconds will fill several screens and it would be necessary to scroll up and down to find the trouble spot.

WHAT TO DO ONCE YOU DISCOVERED A PROBLEM?

There are many different types of problems that can occur with time code. Many times, the solution will depend of how early in the project it was discovered. Following are some very general suggestions

Problems	Solutions
Time code level is too low to be recognized by synchronizer	Reshape time code through the SR-15+
Synchronizer glitches due to level fluctuations on time code track	Reshape time code through the SR-15+
Time code is synchronous but out of phase with video	Use a delay line to delay time code until the phase display reads "bit 79"
Time code is non synchronous with video	Generate new time code referenced to video
There is a hole in the time code track (i.e. accidental punch in)	Use a time code generator set to jam-sync and regenerate new code
Repeated frame or missing frame	Regenerate new time code
The wrong time code format was recorded	Regenerate new code with a generator that can do format conversions

Appendix A: Time Code Error Messages:

“Fatal” errors are the ones considered serious enough to cause a synchronization problem. All “fatal” errors are reported on the front panel and activate the buzzer and the relay; “fatal” and “non fatal”, both appear on the report, with their corresponding time code address.

FATAL ERRORS: (the errors are reported on the front panel display as shown in parentheses)

Drop out (“DROP OUT”):

Interruption of time code for less than 1 second. Level has to fall below input threshold of -30dB.

Code Stopped (“CODESTOP”):

Interruption of time code for more than 1 sec.

Repeated Frame (“DISCONT”):

Same frame address detected twice consecutively.

Discontinuous address (“DISCONT”):

Any non continuous address (either ascending or descending)

Invalid Address (“INVALID”):

Any non valid number such as 39 frames or 75 minutes.

Video Loss (“VID-LOST”):

Any interruption in the video signal.

Format Change (“FORM CHG”):

Change in the time code count.

Wrong number of frames dropped (“DROP X”):

Reports errors in Drop Frame format. Indicates how many frames were dropped.

Change in DF status (“DROP CHG”)

Reported if DF flag changes.

Change in Color status (“COLR CHG”)

Reported if Color flag changes.

NON FATAL ERRORS: Note: some of these messages are not errors but just changes.

Bad Bit: XX

Any bit wider or narrower than $\pm 25\%$ of time code specifications.
XX indicates the number of bad bits for that frame.

Bad Sync Word

Reported if no Sync Word was detected after 256 bits.

Code not in Sync with Video

If time code slips by more than 2 bits with respect to video“V” drive.

Undefined Bit Set

Reported if one of the undefined bits is set (SMPT: bit 58 / EBU: bits 10 & 58).

Alternate bit width window

Reported if the SR-15+ had to go to this setting in order to read time code (see pg 11).

Change in User status

Reported if UB flag changes.

User Bit Change

If User Bits messages change, the first 30 different messages are reported. After that, the SR-15+ disregards any change until reset.

External trigger in

Reported with its coinciding time code address, when tip and sleeve of the 1/4” input jack are shorted.

Code Restarted

Follows a “Code Stopped” message. Indicates where time code reappeared.

Video Restarted

Follows a “Video Loss” message. Indicates where Video reappeared.

Still Frame:

Reported if the same address is detected consecutively, 3 times or more.

Appendix B: More on the Frame Rate Counter...

Since the least significant digit's (LSD) resolution is $\pm .01$ frames per second (.033%), any wow, flutter or speed variation of your time code source is easily detected.

a. Time code generators generally display a very steady frame rate with no fluctuation, whether on internal crystal, external video or tone reference. A \pm one LSD fluctuation probably would not cause any problems.

b. Analog tape machines have typical wow/ flutter speed specifications of $\pm .03\%$ to $\pm .1\%$ (or more). Therefore a fluctuation of 2 (or even 3) LSD is normal. Machines like the Sony APR-24 or Otari MTR-90 are quite stable and may only move 1 LSD every 5 to 10 sec.

c. 3/4" VCR's have wow/ flutter specs up to .3%. They can therefore fluctuate almost .1 frame; the address track is usually more stable than the 2 audio tracks. However a machine in good condition usually fluctuates less than $\pm .1$ frames.

Appendix C: Extracting 62.50Hz tone from 25 fr/sec code

To sync American film (24 fr/sec) to European video (25 fr/sec) it is sometimes useful to have a 62.50 Hz pilot tone in sync with the 25 fr/sec source (62.50 is to 60.00 as 25 is to 24).

The SR-15+ uses 2 different conversion formulas for stripping tone: one for 30 and 25 fr/sec code (x2) and another for 24 fr/sec code (x2.5). To convert 25 fr/sec code into 62.50Hz tone, you need the x2.5 formula.

You can do that by "fooling" the SR-15+: connect a generator set to 24 fr/sec into the SR-15+'s front input; connect your 25 fr/sec time code source into the rear input; set the input selector switch to "Front". As soon as the SR-15+ has identified 24 fr/sec. code, switch to the rear input. The Stripper will use the x2.5 formula and output 62.50 Hz in sync with your 25 fr/sec source.

Make sure the beeper is switched off since the SR-15+ will report a lot of errors due to the format change.

Appendix D: Protecting the SR-15+ outputs from DC voltage on the load:

In remote trucks, it may be necessary to protect the SR-15+ outputs from DC voltage on the load. Pads are provided near the XLR out put connectors for a protective capacitor. A $100\mu\text{f}$ @ 50v should work fine (such as Panasonic part No: ECE-A1HN101S). With it, the SR-15+ will drive a load of 600Ω without any problem.

To install those capacitors, cut the traces between the 2 center pads and solder the capacitors as shown on the drawing at right. For convenience, two additional pads are provided so that, by bending the leads, the capacitors can be soldered from the top without having to remove the circuit card from the chassis.

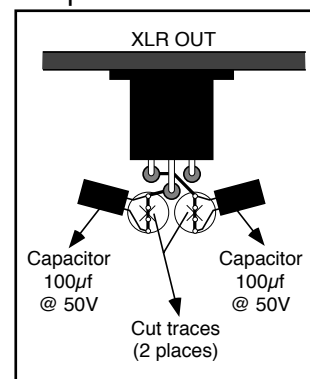

Appendix E: More on the video phase display...

When the SR-15+ detects F1L5 (actually F1L4 ½ as detected by the LM1881 video sync detector), it looks at which bit is in the time code working register. The number of that bit is displayed in the video phase window. However, the highest resolution of time code is one bit which is about 417 µsec. while a video line is about 63 µsec. This means that there are approximately 6 ½ video lines per time code bit.

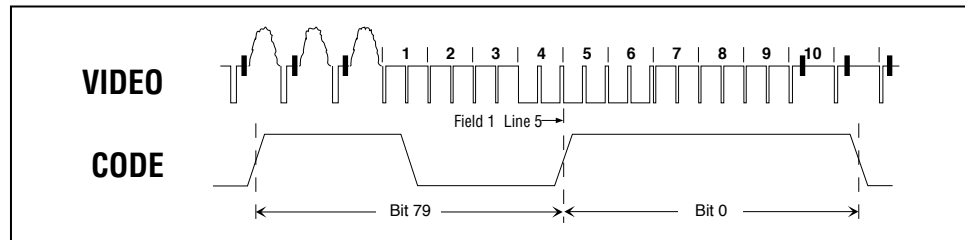

Figure 21. Proper alignment of video and time code

If aligning your VCR's address track with the SR-15+, move the address track head until you read "bit 00" then move back a little and stop as soon as you read "bit 79". This way, the trailing edge of bit 79 will be aligned with F1L5.

Appendix F: Identifying color field with time code address:

When a generator generates "Color Framed" time code it is locked to a Field ID reference pulse and uses the following rules to keep the time code addresses relative to the color sequences:

- ⇒ For NTSC, the color sequence is spread over 4 fields (2 frames). For correct color framing, even-numbered frames contain fields 1 and 2 (Frame A) and odd-numbered frames contain fields 3 and 4 (Frame B) of the sequence.

For example, time code address 00:04:12:13 contains fields 3 and 4 of the 4 field NTSC color sequence (Frame B).

- ⇒ For SECAM and simple PAL editing, the color sequence is spread over 4 fields (2 frames). For correct color framing, if S represents the number of seconds and F the number of frames in the time code address,

S + F is an odd number for fields 1 and 2 of the sequence

S + F is an even number for fields 3 and 4 of the sequence

For example, time code address 00:04:12:13 contains fields 1 and 2 of the 4 field SECAM color sequence since $S + F = 25$ (odd).

- ⇒ For more complex PAL editing, the color sequence is spread over 8 fields (4 frames). If S represents the number of seconds and F the number of frames, when dividing S+F by 4, the remainder is

0 for fields 7 and 8 of the sequence (frame D)

1 for fields 1 and 2 of the sequence (frame A)

2 for fields 3 and 4 of the sequence (frame B)

3 for fields 5 and 6 of the sequence (frame C)

For the time code address 01:02:15:22, for example, $S+F=37$. The remainder when dividing by 4 is 1 (i.e.: $37/4 = 9$ with a remainder of 1). So this address corresponds to fields 1 and 2 of the 8 field PAL color sequence.

Appendix G: Longitudinal bit assignment: SMPTE & EBU.

Each word of LTC is divided into 80 equal segments called bits, numbered 0 to 79. These bits are mainly grouped by four into Binary Coded Decimal words to form decimal numbers (0 to 9). Twenty six of these bits are assigned to the Time Address information (frames, seconds, minutes and hours); thirty two are assigned to the Binary Group information (user bits); sixteen are used for sync (sync word) and the remaining six are used for flags or are still unassigned.

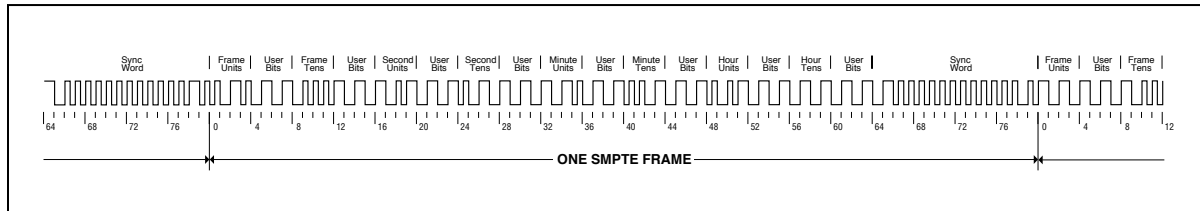

Figure 22. SMPTE Word: Address: 05:38:14:29 - User bits: 0000000 - drop & color flags set.

SMPTE has a frame rate of 30 fr/s and EBU 25 fr/s but both time codes have the same 80 bits per word. Most bits are the same but some of the flags are different.

Bit No.	Assignment
0	1
1	2
2	4
3	8
4	4
5	5
6	6
7	7
8	10
9	20
10	DROP FRAME FLAG
11	COLOR FRAME FLAG
12	13
13	14
14	15
15	16
16	1
17	2
18	4
19	8
20	4
21	5
22	6
23	7
24	10
25	20
26	26
27	BI-PHASE MARK PHASE CORRECTION BIT
28	29
29	30
30	31
31	32
32	1
33	2
34	4
35	8
36	4
37	5
38	6
39	7
40	10
41	20
42	40
43	BINARY GROUP FLAG BIT
44	45
45	46
46	47
47	48
48	1
49	2
50	4
51	8
52	4
53	5
54	6
55	7
56	10
57	20
58	UNASSIGNED ADDRESS BIT 58
59	BINARY GROUP FLAG BIT
60	61
61	62
62	63
63	64
64	SYNC WORD - BIT "ZERO"
65	SYNC WORD - BIT "ZERO"
66	SYNC WORD - BIT "ONE"
67	SYNC WORD - BIT "ONE"
68	SYNC WORD - BIT "ONE"
69	SYNC WORD - BIT "ONE"
70	SYNC WORD - BIT "ONE"
71	SYNC WORD - BIT "ONE"
72	SYNC WORD - BIT "ONE"
73	SYNC WORD - BIT "ONE"
74	SYNC WORD - BIT "ONE"
75	SYNC WORD - BIT "ONE"
76	SYNC WORD - BIT "ONE"
77	SYNC WORD - BIT "ONE"
78	SYNC WORD - BIT "ZERO"
79	SYNC WORD - BIT "ONE"

Figure 23. SMPTE longitudinal bit assignment

Bit No.	Assignment
0	1
1	2
2	4
3	8
4	4
5	5
6	6
7	7
8	10
9	20
10	UNASSIGNED ADDRESS BIT 10
11	COLOR FRAME FLAG
12	13
13	14
14	15
15	16
16	1
17	2
18	4
19	8
20	4
21	5
22	6
23	7
24	10
25	20
26	26
27	BINARY GROUP FLAG BIT
28	29
29	30
30	31
31	32
32	1
33	2
34	4
35	8
36	4
37	5
38	6
39	7
40	10
41	20
42	40
43	BINARY GROUP FLAG BIT
44	45
45	46
46	47
47	48
48	1
49	2
50	4
51	8
52	4
53	5
54	6
55	7
56	10
57	20
58	UNASSIGNED ADDRESS BIT 58
59	BI-PHASE MARK PHASE CORRECTION BIT
60	61
61	62
62	63
63	64
64	SYNC WORD - BIT "ZERO"
65	SYNC WORD - BIT "ZERO"
66	SYNC WORD - BIT "ONE"
67	SYNC WORD - BIT "ONE"
68	SYNC WORD - BIT "ONE"
69	SYNC WORD - BIT "ONE"
70	SYNC WORD - BIT "ONE"
71	SYNC WORD - BIT "ONE"
72	SYNC WORD - BIT "ONE"
73	SYNC WORD - BIT "ONE"
74	SYNC WORD - BIT "ONE"
75	SYNC WORD - BIT "ONE"
76	SYNC WORD - BIT "ONE"
77	SYNC WORD - BIT "ONE"
78	SYNC WORD - BIT "ZERO"
79	SYNC WORD - BIT "ONE"

Figure 24. EBU longitudinal bit assignment

Specifications

Time Code Reader:

8 digit display - character height: .12"
Speed range: reads at play speed only ($\pm 25\%$)

Frame Rate Counter:

4 digit display - character height: .12"
Reads: frame rate w/ "Code" selected
frequency w/ "Tone in" or "Tone out" selected
Reading range: ≈ 21 to 39 fr/sec or ≈ 5 to 99.99 Hz
Display accuracy: ± 20 ppm plus $\pm \frac{1}{2}$ the least significant digit
Resolution: .01 Fr/sec or Hz
Update rate: 4x per sec.

Distributor / Reshaper:

1 x 5 with auxiliary front panel input and output
Input signal: SMPTE/EBU Longitudinal Time Code (forward or reverse, play, shuttle & wind)
Input Impedance: 20K Ω balanced; 10K Ω unbalanced
Input Level: -30dbU min; +20dbU max
Output Impedance: 600 Ω balanced; 300 Ω unbalanced
Output Level: full off to +12dbU balanced; to +6dbU unbalanced front panel pots adjustable
Output Waveform: switchable rise time (front panel switch):
25 μ s (SMPTE), 50 μ s (EBU), or 1 μ s (square wave)
Amplitude Distortion (output): less than 2%

Tone Stripper:

Output Level: full off to +12dbU balanced; to +6dbU unbalanced front panel pot adjustable
Output waveform: Sine (low distortion sine wave) or Square.
Time Code Conversion: 24 fr/sec (film) 60Hz
25 fr/sec (PAL) 50Hz
29.97fr/sec (NTSC) 59.94Hz
30 fr/sec (SMPTE) 60Hz
Video conversion: NTSC color 59.94Hz
PAL 50 Hz

Connectors:

XLR Female (2 inputs); Male (6 outputs)
BNC: Video In & Loop / Color ID In & Loop / Video Out (optional)
1/4" Jack: Tip-Ring-Sleeve type - for relay out or event in
DB-9M: Serial port
DB-25F: Parallel port
IEC 320: Power inlet

Termination switch: 75 Ω to ground - for Video In & Loop

Ground Lift Switch: Isolates chassis ground from signal ground

Power: 115 VAC / 230VAC @ 50 or 60 Hz (switchable)

Fuse: 250V T200mA (slow blow, type 218) @ 115VAC

250V T100mA (slow blow, type 218) @ 230VAC

Size: 5 x 20 mm (metric)

Dimensions: 19" x 1 $\frac{3}{4}$ " x 9 $\frac{1}{2}$ "

Weight: 8lbs

BRAINSTORM ELECTRONICS, INC.
www.brainstormtime.com

Distributed Exclusively by

plus24

1155 N. La Brea Avenue, West Hollywood, CA 90038 - USA
Tel: (323) 845-1171 - Fax: (323) 845-1170
www.plus24.net