

DIGITAL DELAY SDE-3000

OWNER'S MANUAL



The Roland Rack

Features

The Roland Digital Delay SDE-3000 is a high quality Delay Machine featuring various delay effects and also the Memory function that retains up to eight different panel settings. Therefore, it is extremely helpful for both studio and live performance.

- Adopting the companding PCM equivalent to 16 bit, the SDE-3000 offers such wide dynamic range (100dB) and low harmonic distortion (0.03%).
- Long Delay of 4.5s (Frequency Characteristic: 20Hz to 8kHz) is now available, which is specially useful for live performance.
- The entire Front Panel setting can be stored into memory. (The Input Level is not included here.)
- The accuracy of the Delay Time Display is as good as 0.4%. The time is indicated by 0.1ms step up to 10ms, and after that by 1ms step.
- The Input and Delay Output levels can be controlled, so that the lowest S/N ratio and widest Dynamic Range can be attainable.
* Basically, using the SDE-3000 as a Pre-amplifier should be refrained, as it is designed to be UNITY (Output: Input = 1:1).
- The FEEDBACK LOOP SEND and RETURN Jacks allow wide variety of the effect sounds.
- The Output jack for the inverted Modulation CV is useful for when two sets of the SDE-3000's are used.
- The Remote Control Jacks such as DELAY ON/OFF, HOLD, PRESET SHIFT are provided for even wider variety in live performance.

Important Notes

- Be sure to use the voltage shown on the Name Plate on the rear panel.
- The SDE-3000 may generate heat during operation, this is quite normal situation caused by AC power, and there is nothing to worry about it.
- Please never disassemble the SDE-3000 even if it breaks down.
- If the SDE-3000 is not to be used for a long period of time, unplug the cord from the socket.
*Please do not pull the cord but hold the plug when unplugging.
- Please avoid placing or dropping anything heavy on the Power Cable.
- Operating the SDE-3000 near a neon or fluorescent lamp may cause noise interference. If so, change the angle of the SDE-3000.
- Avoid using the SDE-3000 in extreme heat, humidity or where it may be affected by dust.
- Use mild detergent for cleaning. Do not use solvent such as thinner.

Contents

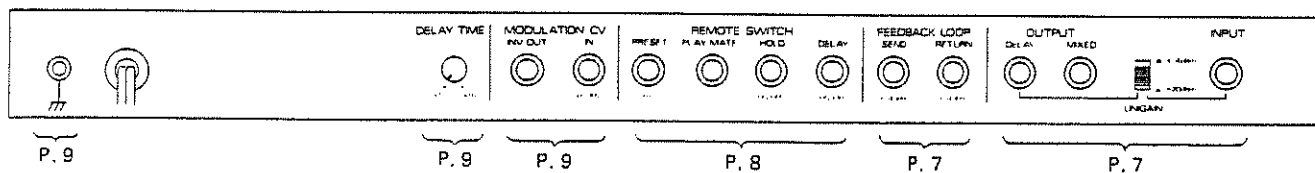
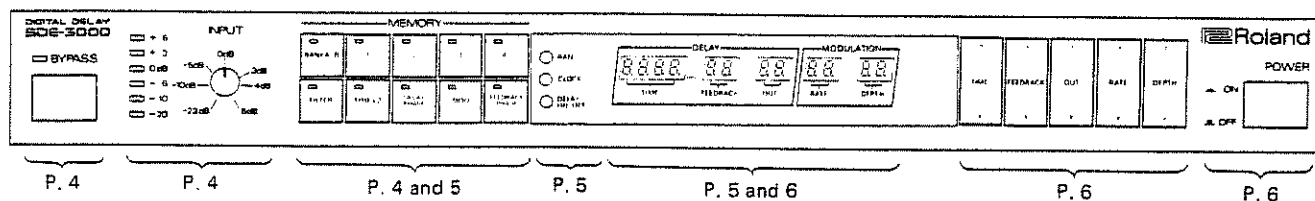

Memory Function	10
Setting up	11
Sample Sounds	13
Original Memo	15
Block Diagram	17
Frequency Characteristic	18
Specifications	19

Panel Descriptions

BYPASS

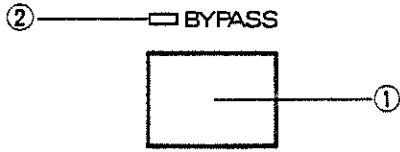

① BYPASS Switch (ON)
 This is a mechanical Bypass Switch, therefore even when the SDE-3000 is turned off, the input signal is perfectly passed through and sent out.

* If this switch is turned on or off while the SDE-3000 is operating, noise may be caused, but there is nothing to worry about it.

② BYPASS Indicator
 This indicator lights up when the SDE-3000 is in the Bypass mode.

* This does not go on when the SDE-3000 is turned off.

INPUT

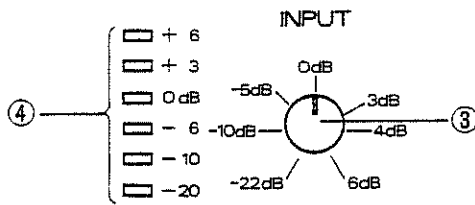

③ INPUT Attenuator
 When this knob is set to 0dB, the output level is equal to the input level. Set this knob to appropriate level where the Input Level Indicator +6dB lights up at its peak.

* Even if this knob is turned fully counterclockwise, the level will not be zero.

④ Input Level Indicators
 The level of the attenuated input signal is shown here.

* If the Input/Output Level Selector Switch is set to the +4dBm (-20dBm) and INPUT Attenuator is set to "0", feeding +4dBm (-20dBm) signal lights up the 0dB indicator.

MEMORY

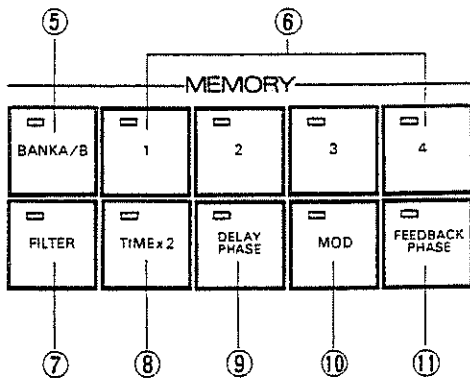

⑤ Memory Bank Selector Switch with Indicator
 When Bank A is selected, the red indicator lights up, and the green Indicator lights when Bank B is selected.

⑥ Memory Channel Selector Switches with Indicators
 You can choose any of the eight channels just by pressing a switch.

 → Refer to P.8

*If you wish to write a panel setting into memory, select a channel then keep pressing the corresponding switch for a few seconds until the Memory Channel indicator starts blinking. If you just touch the switch, the existing setting will be recalled. (Refer to P. 10).

⑦ Delay Filter Switch with Indicator

When the SDE-3000 is used as an echo machine, by using this Delay Filter Switch, a realistic echo effect is obtained.

*The Frequency Characteristic of the Delay signal will change.

⑧ Delay Range Switch with Indicator

This switch is to change the delay range.

	Delay Time	Frequency Characteristics
OFF (x1)	0~1500ms	10~17kHz (+0.5dB / -3dB)
ON (x2)	0~3000ms	10~ 8kHa (+0.5dB / -3dB)

INDICATORS

- RATE ——— ⑫
- CLOCK ——— ⑬
- DELAY ON/OFF ——— ⑭

⑫ Modulation Rate Indicator

This blinks at the same rate as the LFO's.

*This Indicator will blink whether the MODULATION Switch is on or off.

⑨ DELAY PHASE Switch with Indicator

By using this switch, the phase of the delay sound can be inverted. (This effect is most effective if used with the Modulation.)

⑩ MODULATION Switch with Indicator

With this switch, you can turn the Modulation on or off.

⑪ FEEDBACK PHASE Switch with Indicator

By using this switch, you can invert the feedback phase of the delay sound.

< Note >

The SDE-3000 features battery back up system to retain the memory even when switched off. The batteries should be replaced with a new set in every five years. In this case, please have your local Roland dealer do the job. (The first replacement may be required before five years.)

⑬ Delay Clock Indicator

This indicator lights up at the intervals of the current delay time.

⑭ DELAY ON/OFF Indicator

This goes out only when the Delay effect is turned off by using the Foot Switch.



DISPLAY

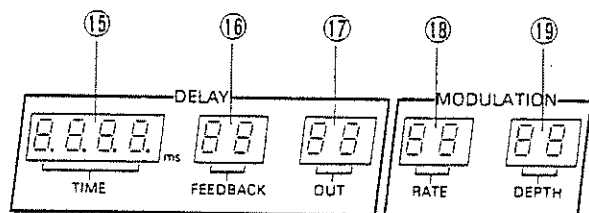

The Delay Time Display changes "0" to "4500" and other displays (⑬ to ⑱) change "0" to "99".

⑮ DELAY TIME Display

This shows the Delay Time.

⑩ FEEDBACK Level Display

This shows the Feedback level.

*When "0" is shown on the Display, a single delay is obtained.

⑪ DELAY OUTPUT Level Display

This shows the output level of the delay signal.

*When only the MIXED OUTPUT Jack is used, "60" on the Display means Direct output level: Delay output level = 1:1. If the DELAY OUTPUT Jack is being used, Input Level: Delay out level = 1 : 1.

⑫ MODULATION RATE Display

The number shown here corresponds to the frequency of the built-in LFO.

*The number in the Display changes "0" to "99".

⑬ MODULATION DEPTH Display

The number shown here corresponds to the depth of the modulation by the built-in LFO or external CV.

*When "0" is shown in this Display, the Modulation is off.

CONTROL

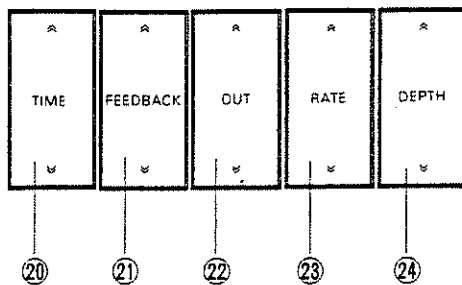

⑳ DELAY TIME Button

This is used to set the Delay Time. Pressing the upper part ^ will advance the figure on the Display, making the Delay Time longer, and pressing v side will shorten it.

The Delay Time shown in the Display Window may slightly alter after a while. Even so, there is nothing to worry about it, simply adjust it right.

㉑ FEEDBACK Level Button

This is to set the Feedback level. Pressing ^ side will raise the level.

㉒ DELAY OUTPUT Level Button

This is to set the output level of the delay sound. Pressing ^ side will raise the level.

*When the Load Impedance is 50kΩ, "60" in the display means UNITY.

㉓ MODULATION RATE Button

This sets the frequency of the built-in LFO (0.05Hz to 10kHz). Pressing ^ side will quicken the rate.

㉔ MODULATION DEPTH Button

This sets the depth of the LFO or external CV Modulation. Pressing ^ side will deepen the effect.

* Pressing one side while holding the other side down will quicken this change. This applies to the other four buttons ㉑ to ㉓.

POWER

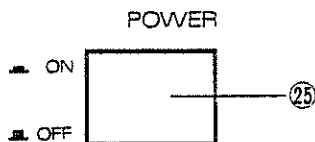

㉕ POWER Switch

*The SDE-3000 stays muted for about ten seconds even after turned on. Neither the direct or delay sound is output. The panel setting remains as it is even if the SDE-3000 is turned off. (Refer to <Notes> on P. 7)

INPUT AND OUTPUT JACKS

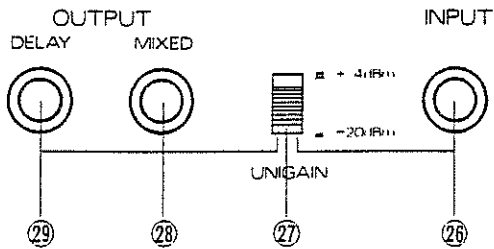

②⑥ INPUT Jack

* For feeding low level input such as a microphone, preamplifier or microphone amplifier may be needed.

②⑦ Input/Output Level Selector Switch

Set this switch to +4dBm or -20dBm depending on the instrument or equipment you use.

* Please be sure to select the proper position to obtain the best possible delay effect.

The following is a rough category for setting this switch.

- +4dBm: Roland Rack System
Professional Audio Equipment, etc.
- -20dBm: Electric Musical Instruments such as a synthesizer.
Ordinary Audio Equipment, etc.

②⑧ MIXED OUTPUT Jack

②⑨ DELAY OUTPUT Jack

- ▶ If only the MIXED OUTPUT Jack ②⑧ is used, both the direct and delay signals come out.
- ▶ If only the DELAY OUTPUT Jack ②⑨ is used, only delay signal comes out.
- ▶ If both jacks are used, direct signal comes out from the MIXED OUTPUT Jack ②⑧ and delay signal from the DELAY OUTPUT Jack ②⑨.

<Notes>

In the following cases, delay sound is completely muted; therefore, only the direct sound is heard.

1. When you change the delay time:
The delay sound is muted as long as the DELAY TIME Button is depressed, and still muted even after the button is released until the SDE-3000 gets the stand-by mode.
* Here, the DELAY TIME Indicator does not light.
2. When recalling from Memory:
The delay sound is muted as long as the Delay Time shown on the Display.
3. When the DELAY RANGE Switch is set to the "x 2" position:
The delay sound is muted as long as the delay time of the "x 1" mode.
* If the DELAY TIME Button is depressed while the Hold Repeat function is on, the repeating delay sound may be muted.

FEEDBACK LOOP

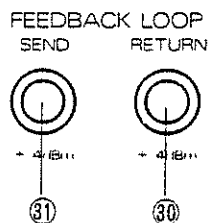

③① FEEDBACK LOOP SEND/RETURN Jack

These are used to connect an effect device for processing the feedback signal. (Refer to P. 12)

* Use the device whose rated output/input level is +4dBm (e. g. Roland Rack System).

REMOTE SWITCH

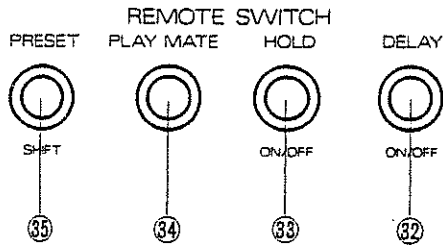

32 DELAY Remote Jack

By connecting the Foot Control such as FS-1 or DP-2, the delay effect can be turned on or off with the Pedal.

* Pressing the DP-2 turns the delay effect on and releasing it turns it off.

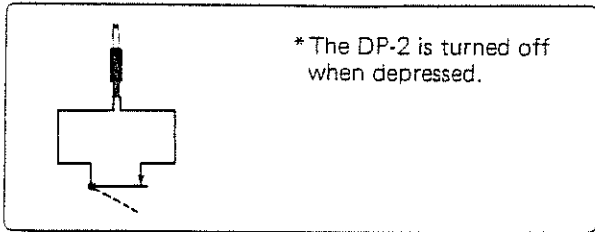
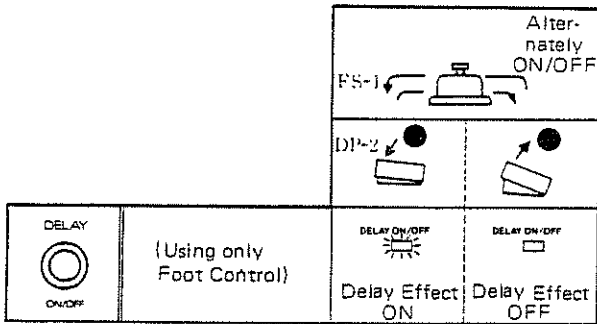

33 HOLD Remote Jack

You can turn the Delay Hold function on or off by connecting the Pedal Switch DP-2 to this jack. While the Pedal is depressed, the sound will be repeated.

* This effect cannot be obtained if the delay time is shorter than 20ms. When this function is being used, the Memory Channel Selector (6), DELAY TIME Button (20) or Preset Shift Jack (35) have no effect.

34 PLAY MATE Jack

This is to connect to the Pedal Switch (DP-2). You can set a Delay Time of any length just by pressing the Pedal in such timing. The following shows the necessary procedure.

1. Connect the DP-2 to the PLAY MATE Jack. The Delay Time Display will show "0. 0. 0. 0." (Stand-by mode), and the DELAY ON/OFF Indicator remains dark (the Delay effect is off).
2. Press the DP-2 twice, and the built-in computer sets the Delay Time according to the interval between the first pressing and the second.
3. If you press the Pedal once again, the DELAY TIME Display shows "0. 0. 0. 0." and the SDE-3000 is in the Stand-by mode again.

* The longest Delay Time you can set in the SDE-3000 is about three seconds, so if you happen to set the Delay Time exceeding three seconds, the DELAY TIME Display flashed showing the maximum Delay Time (3000). In such a case, press the DP-2 and set the Delay Time again.

35 PRESET Shift Jack

By connecting the Pedal Switch (DP-2) to this jack, eight Preset Panel settings in memory can be sequentially called.

MODULATION CV

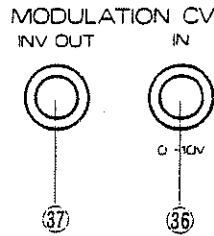

③⑥ External CV Input Jack

The external modulation CV is input through this jack.

* Plugging into this jack automatically cuts the SDE-3000's internal LFO signal, therefore, the Modulation Rate (①⑧, ②③) has no effect. But the Depth (①⑨, ②④) still affects the modulation, so adjust it to your taste.

When using two sets of the SDE-3000's to obtain symmetrical movement in the stereo field ("seesaw" effect, etc), set the depth of the two SDE-3000's to the same value.

③⑦ Inverted CV Output Jack

Through this jack, inverted LFO CV is output. When the two SDE-3000's are simultaneously in use, their modulation signals can be synchronized by using this jack.

DELAY TIME

DELAY TIME

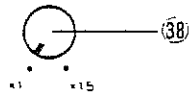

③⑧ DELAY TIME Expanding knob

With this knob, Delay Time can be increased up to 1.5 times (Normally this should be set to "x 1").

< Notes >

- * When using this function, make sure that the Modulation is off and a PLAY MATE Jack is not used.
- * If you use the instrument other than electric guitar or bass, a beat may be caused. If so, rotate the DELAY TIME Expanding Knob counterclockwise until the beat stops.

* If the Feedback Level is high, the SDE-3000 may start oscillating at high pitch. If so, reduce level or rotate this knob counterclockwise until the oscillation stops.

* When writing a Panel setting or recalling it, set this switch to the same level.

* If setting such a long delay time that is not possible to set in the "x 1" mode, the delay time later in use in the "x 1" mode will not be longer than the maximum delay time of "x 1" mode.

* When the Modulation Switch is set to on, rotating the Delay Time Expanding Knob does not affect the Delay Time Display.

* To see the current delay time, simply set the Modulation Switch to the OFF position once.

EARTH

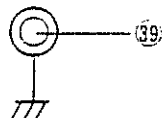

③⑨ Earth Jack

* Ground Wire connection is required for safety.

Memory Function

How to write a Panel Setting into Memory

1. Set the Panel to your taste.

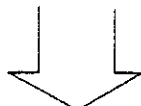
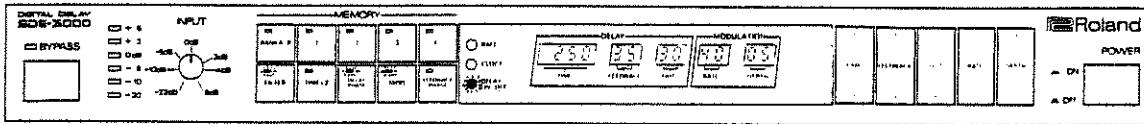

2. Select either Bank with the BANK Selector Switch.
 * Eight different Panel Settings can be written into memory. Each one of the Channels A-1 to A-4 and B-1 to B-4 can store one Panel Setting.

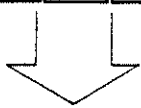
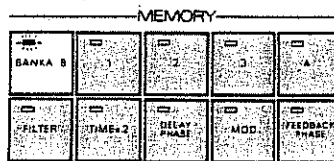

3. Press any of the four Channels for about two seconds.

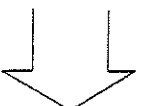
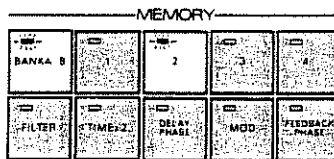

4. If writing has been completed, the Memory Channel Indicator lights up.

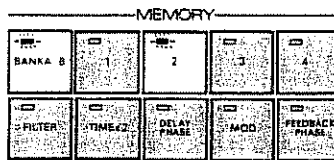

*The Panel Setting to be written into Memory includes those settings shown in the Display Windows and whether the Delay Filter, Delay Range, Delay Phase, Feedback Phase and Modulation Switches are turned on or off. Please note that the Input level is not included.
 *If you release the switch quickly, the existing panel setting will be recalled to be currently in use.

Setting up

INPUT, OUTPUT

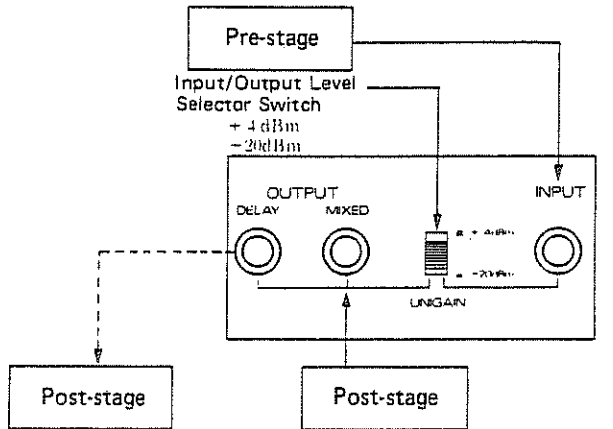

*The SDE-3000 can select rated input level between +4dBm and -20dBm, i. e. it is designed to have UNITY gain (Input level: Output level = 1:1). Therefore, SDE-3000 should be set up between the two devices whose rated input levels are +4dBm or -20dBm. (There should be no level difference between the two units connected to the SDE-3000).

▶ When both the MIXED and DELAY are used:
Direct sound from MIXED
Delay sound from DELAY

▶ When only the MIXED is used:
Both Delay and Direct sounds from MIXED

«Electric Guitar»

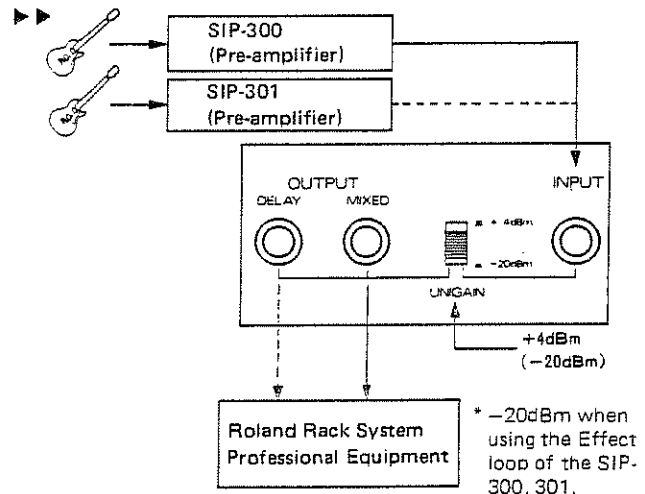
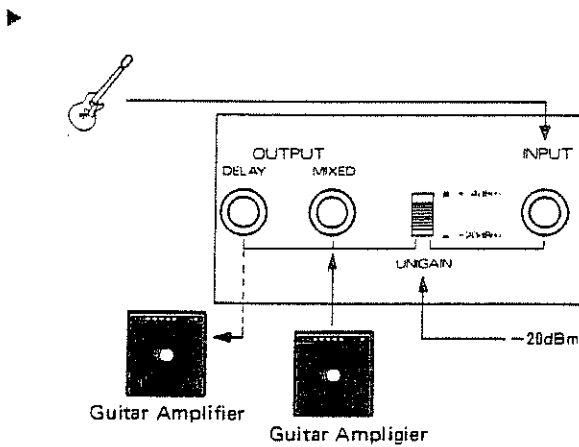

*With the Input/Output Level Selector Switch set to -20dBm, most of the electric guitar can be directly connected.

«Line-level Equipment such as Electronic Keyboard, Audio Equipment, etc.»

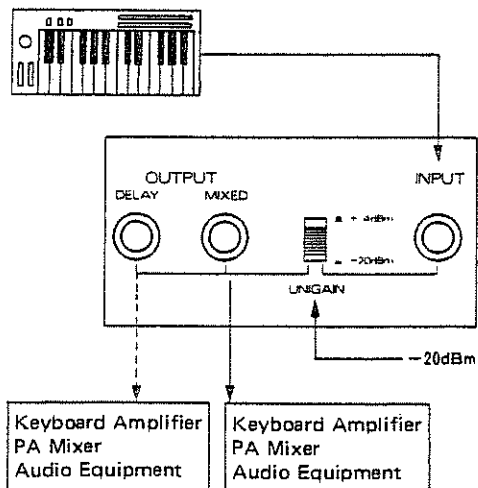

«PA, Mixer»

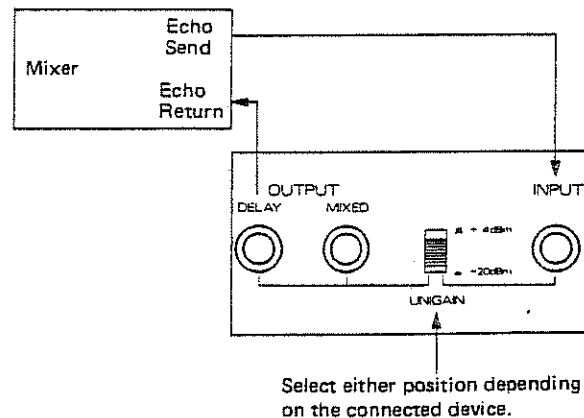

Select either position depending on the connected device.

EXTERNAL CV INPUT

*Modulation by external signal

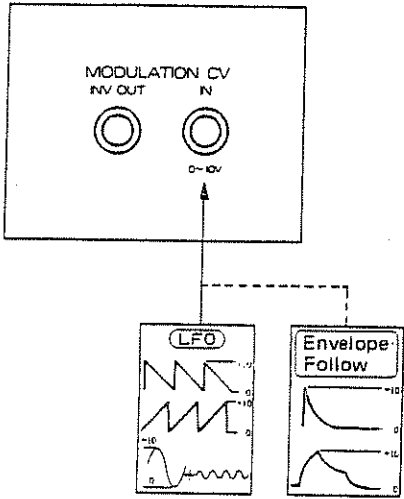

*Controlling the delay time with the Foot Control

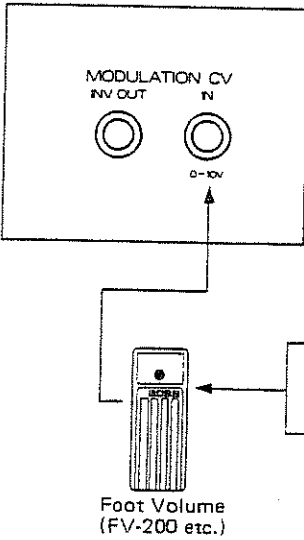

* Pressing the pedal harder will shorten the delay time.
 * Be sure to input the external CV (10V) to the INPUT Jack of the Foot Volume.

* Feeding the external CV (10V) into the External CV Input Jack will shorten the delay time.

FEEDBACK LOOP SEND/RETURN

* Graphic Equalizer

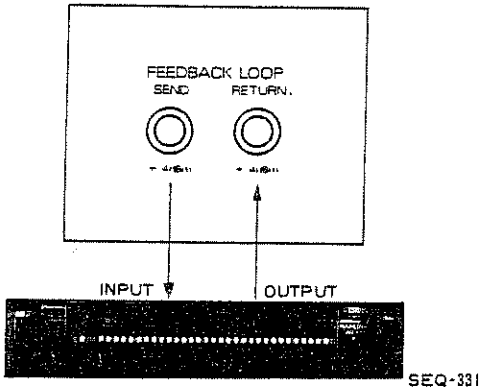

By altering the frequency characteristic of the Feedback, you can enjoy wide variety of echo effects.

* Please try other devices.

SDE-3000 x 2

By using the two sets of the SDE-3000's, seven second delay time is possible to attain.

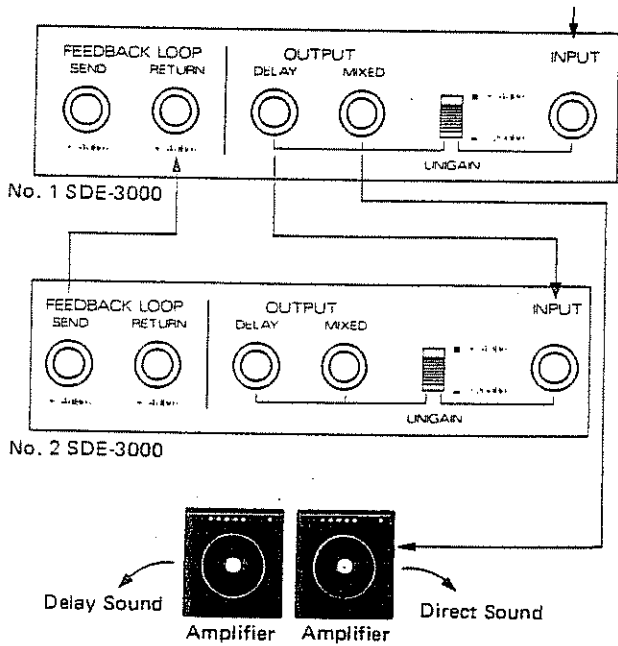

* Feedback level should be controlled with the No. 1 SDE-3000. No. 2 SDE-3000 should be set to produce a single delay.

Original Memo

DIGITAL DELAY SIDE-3000

BYPASS

INPUT

+6
 +3
 0dB
 -3dB
 -6dB
 -10dB
 -15dB
 -20dB

0dB
 3dB
 6dB
 10dB
 15dB
 20dB

MEMORY

DATA B	1	2	3	4
FILTER	TIME1-7	DELAY PHASE	MOD	FEEDBACK PHASE

RATE
 CLOCK
 DELAY ON/OFF

TIME
 FEEDBACK
 OUT
 RATE
 DEPTH

MODULATION

TIME
 FEEDBACK
 OUT
 RATE
 DEPTH

Rolland

POWER ON OFF

DIGITAL DELAY SIDE-3000

BYPASS

INPUT

+6
 +3
 0dB
 -3dB
 -6dB
 -10dB
 -15dB
 -20dB

0dB
 3dB
 6dB
 10dB
 15dB
 20dB

MEMORY

DATA B	1	2	3	4
FILTER	TIME1-7	DELAY PHASE	MOD	FEEDBACK PHASE

RATE
 CLOCK
 DELAY ON/OFF

TIME
 FEEDBACK
 OUT
 RATE
 DEPTH

MODULATION

TIME
 FEEDBACK
 OUT
 RATE
 DEPTH

Rolland

POWER ON OFF

DIGITAL DELAY SIDE-3000

BYPASS

INPUT

+6
 +3
 0dB
 -3dB
 -6dB
 -10dB
 -15dB
 -20dB

0dB
 3dB
 6dB
 10dB
 15dB
 20dB

MEMORY

DATA B	1	2	3	4
FILTER	TIME1-7	DELAY PHASE	MOD	FEEDBACK PHASE

RATE
 CLOCK
 DELAY ON/OFF

TIME
 FEEDBACK
 OUT
 RATE
 DEPTH

MODULATION

TIME
 FEEDBACK
 OUT
 RATE
 DEPTH

Rolland

POWER ON OFF

DIGITAL DELAY SIDE-3000

BYPASS

INPUT

+6
 +3
 0dB
 -3dB
 -6dB
 -10dB
 -15dB
 -20dB

0dB
 3dB
 6dB
 10dB
 15dB
 20dB

MEMORY

DATA B	1	2	3	4
FILTER	TIME1-7	DELAY PHASE	MOD	FEEDBACK PHASE

RATE
 CLOCK
 DELAY ON/OFF

TIME
 FEEDBACK
 OUT
 RATE
 DEPTH

MODULATION

TIME
 FEEDBACK
 OUT
 RATE
 DEPTH

Rolland

POWER ON OFF

DIGITAL DELAY SIDE-3000

BYPASS

INPUT

+6
 +3
 0dB
 -6
 -10
 -20

0dB
 -5dB
 -10dB
 -15dB
 -20dB

MEMORY

BANK A B	1	2	3	4
FILTER	TIME+2	DELAY PHASE	MID	FEDBACK PHASE

RATE
 CLOCK
 DELAY ON OFF

TIME
 FEEDBACK
 OUT
 RATE
 DEPTH

MODULATION

TIME
 FEEDBACK
 OUT
 RATE
 DEPTH

POWER

ON
 OFF

DIGITAL DELAY SIDE-3000

BYPASS

INPUT

+6
 +3
 0dB
 -6
 -10
 -20

0dB
 -5dB
 -10dB
 -15dB
 -20dB

MEMORY

BANK A B	1	2	3	4
FILTER	TIME+2	DELAY PHASE	MID	FEDBACK PHASE

RATE
 CLOCK
 DELAY ON OFF

TIME
 FEEDBACK
 OUT
 RATE
 DEPTH

MODULATION

TIME
 FEEDBACK
 OUT
 RATE
 DEPTH

POWER

ON
 OFF

DIGITAL DELAY SIDE-3000

BYPASS

INPUT

+6
 +3
 0dB
 -6
 -10
 -20

0dB
 -5dB
 -10dB
 -15dB
 -20dB

MEMORY

BANK A B	1	2	3	4
FILTER	TIME+2	DELAY PHASE	MID	FEDBACK PHASE

RATE
 CLOCK
 DELAY ON OFF

TIME
 FEEDBACK
 OUT
 RATE
 DEPTH

MODULATION

TIME
 FEEDBACK
 OUT
 RATE
 DEPTH

POWER

ON
 OFF

DIGITAL DELAY SIDE-3000

BYPASS

INPUT

+6
 +3
 0dB
 -6
 -10
 -20

0dB
 -5dB
 -10dB
 -15dB
 -20dB

MEMORY

BANK A B	1	2	3	4
FILTER	TIME+2	DELAY PHASE	MID	FEDBACK PHASE

RATE
 CLOCK
 DELAY ON OFF

TIME
 FEEDBACK
 OUT
 RATE
 DEPTH

MODULATION

TIME
 FEEDBACK
 OUT
 RATE
 DEPTH

POWER

ON
 OFF

Block Diagram

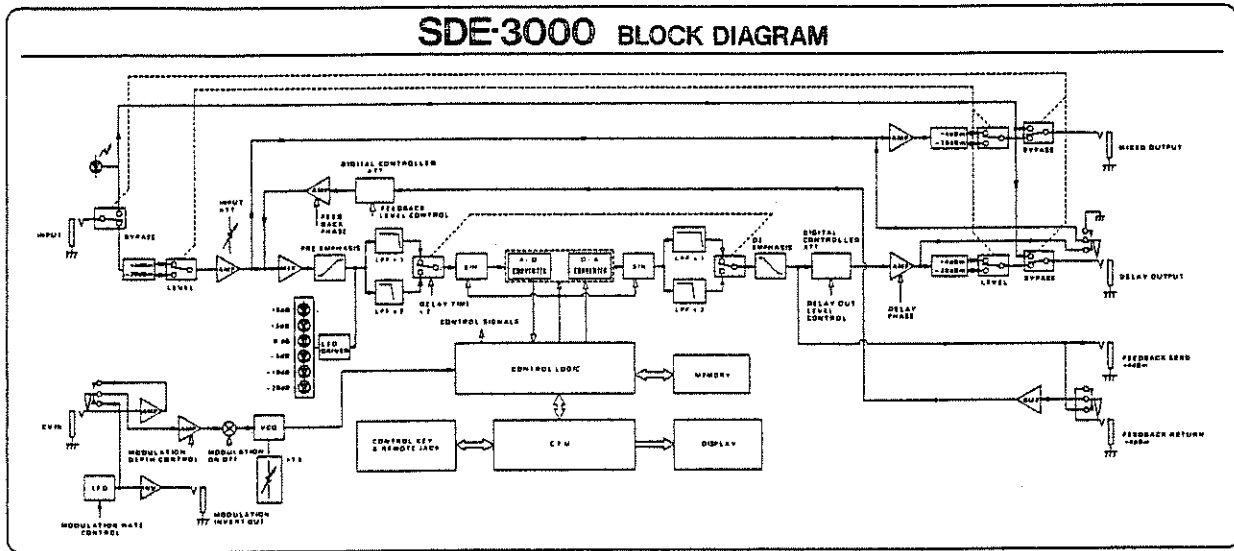

Fixing to the 19" Rack.
Use 5mm screws.

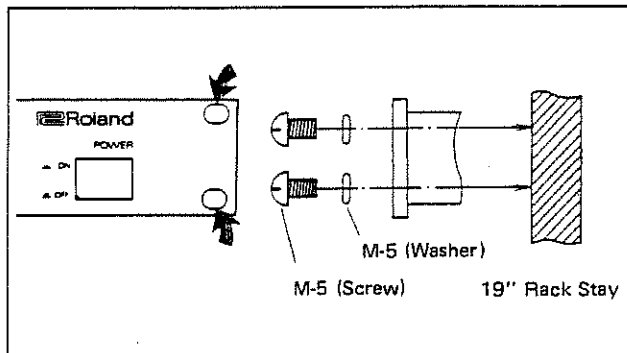

Options

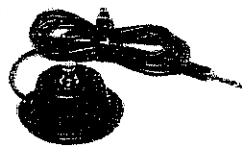

Foot Switch FS-1



Pedal Switch DP-2



Foot Volume FV-200

Frequency Characteristic

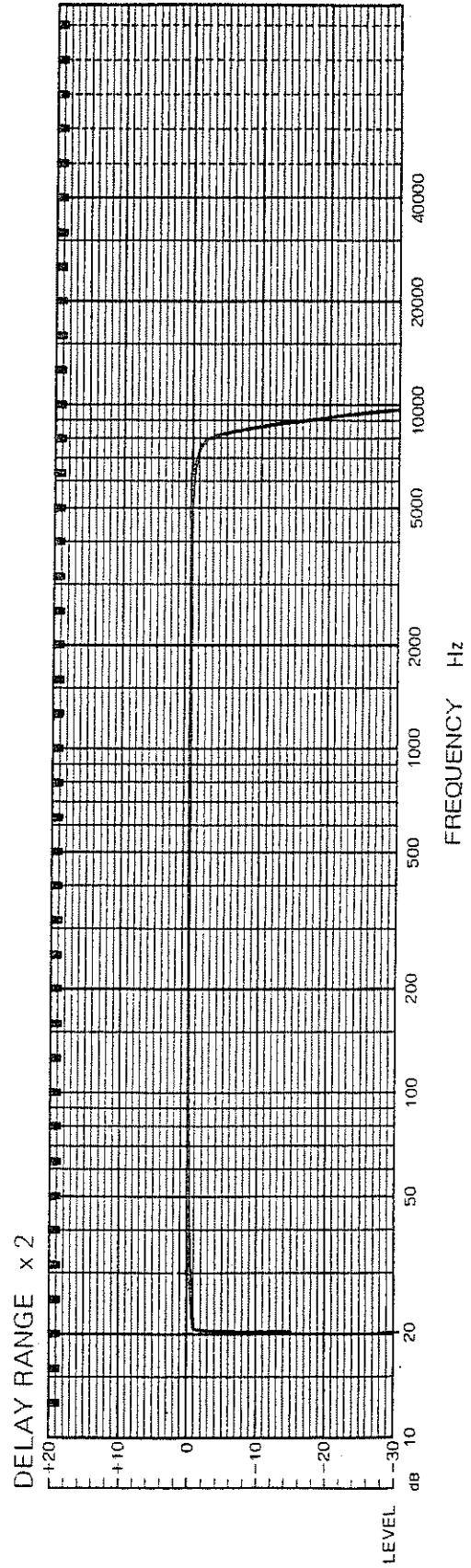
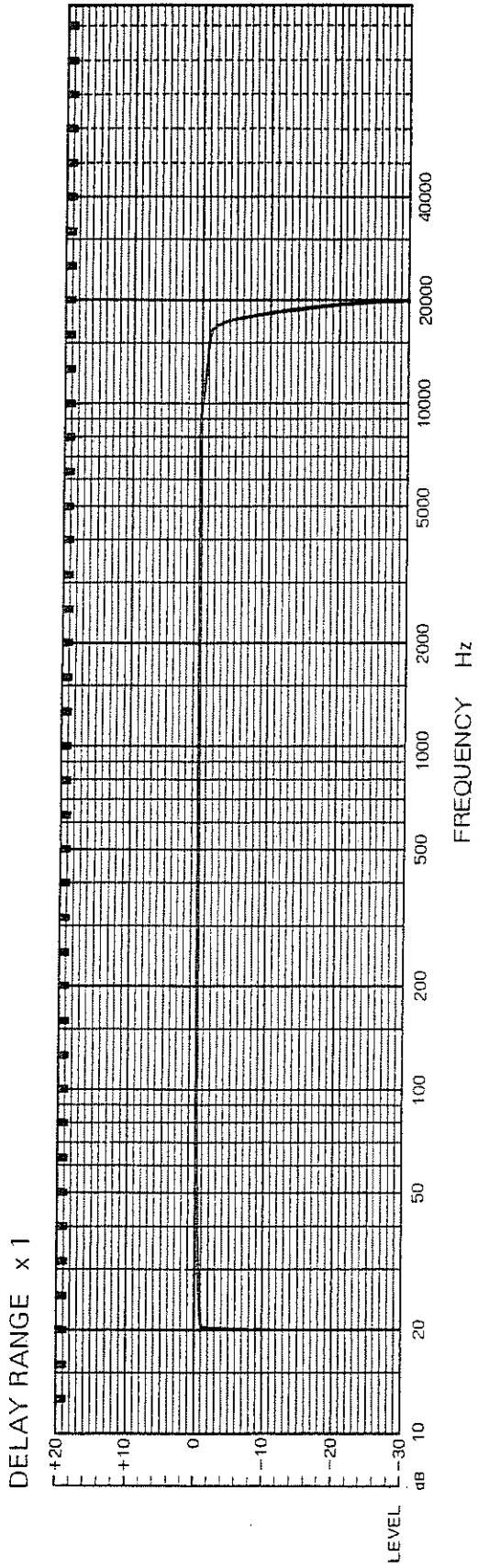

Specifications Digital Delay ● SDE-3000

< Input >

- Input Level +4dBm
-20dBm
- Input Impedance 56 k Ω (+4dBm)
560k Ω (-20dBm)

< Output >

- Output Level +4dBm (+17dBm max.)
-20dBm (-5dBm max.)
- Output Impedance 100 Ω (+4dBm)
650 Ω (-20dBm, Mixed)
650 Ω (-20dBm, Delay)

< Feedback Send >

- Output Level +4dBm (+17dBm max.)
- Output Impedance 100 Ω

< Feedback Return >

- Input Level +4dBm (+17dBm max.)
- Input Impedance 42k Ω

< CV IN >

- Operating Voltage 0 to +10V (\pm 20V)
- Input Impedance 100k Ω

< CV INV OUT >

- Output Voltage 0 to 10V \sim Waveform
- Output Impedance 1k Ω

< General Performance >

- Delay Time Range 0 to 1500ms/0 to 3000ms
(x 1.5VR min.)
0 to 3000ms/0 to 4500ms
(x 1.5VR max.)
0 to 10ms (0.1ms step)
10 to 4500ms (1ms step)
- Frequency Characteristic 10Hz to 100kHz,
+0, -1dB (Direct)
10Hz to 17kHz, +0.5, -3dB
(Delay 0 to 1500ms)
10Hz to 8kHz, +0.5, -3dB
(Delay 0 to 4500ms)
- S/N (IHFA) 100dB (Direct) at rated input/output,
Dynamic Range 112dB (typ)
88dB (Delay) at rated input/output,
Dynamic Range 100dB (typ)
- Total Harmonic Distortion
0.008% typ (Direct) at rated input
0.03% typ (Delay) 1kHz
- Delay Accuracy \pm 0.4%

< Controls >

Input Attenuator
 Delay Feedback Level Button (Up, Down)
 Delay Output Level Button (Up, Down)
 MODULATION RATE Button (Up, Down)
 MODULATION DEPTH Button (Up, Down)
 DELAY TIME Button (Up, Down)
 DELAY TIME Expanding Knob

< Switches >

Memory Bank Selector Switch (A/B)
 Memory Channel Selector Switches (1, 2, 3, 4)
 Delay Filter Switch
 Delay Range Switch
 Delay Phase Switch
 Modulation Switch
 FEEDBACK Phase Switch
 POWER Switch
 Input Output Level Selector Switch
 BYPASS Switch

< Display/Indicator >

Delay Time Display
 Feedback Level Display
 Delay Output Level Display
 MODULATION RATE Display
 MODULATION DEPTH Display
 Input Level Indicators
 Memory Bank Selector Indicator
 Memory Channel Selector Indicators
 Delay Filter Indicator
 Delay Range Indicator
 Delay Phase Indicator
 Modulation Indicator
 FEEDBACK Phase Indicator
 DELAY ON/OFF Indicator
 Delay CLOCK Indicator
 Modulation RATE Indicator
 BYPASS ON/OFF Indicator

< Jacks >

INPUT Jack
 DELAY OUTPUT Jack
 MIXED OUTPUT Jack
 Inverted CV Output Jack
 External CV Input Jack
 FEEDBACK LOOP SEND Jack
 FEEDBACK LOOP RETURN Jack

< Remote Control >

PRESET Shift Jack
 PLAY MATE Jack
 HOLD Jack
 DELAY ON/OFF Jack

< Consumption > 24W

< Dimensions >

482(W) x 46(H) x 310(D) mm
 19(W) x 1-13/16(H) x 12-13/16(D) in.
 19" Rack mount (EIA-1U)

< Weight >

5 kg/11 lb.

< Accessories >

Connection Cable x 2

* Specifications are subject to change without notice.

 Roland®

10626

UPC

10626

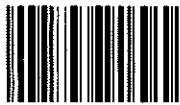

19961

 Roland